

# Combison A

600x600, 1200x600

M398

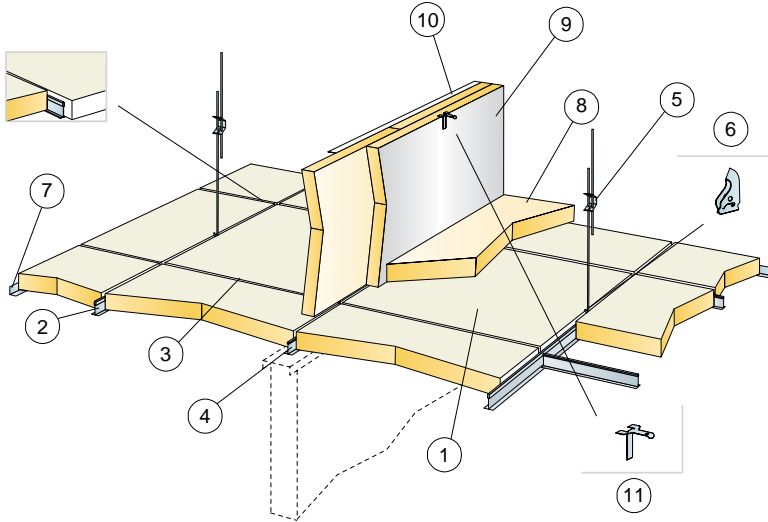
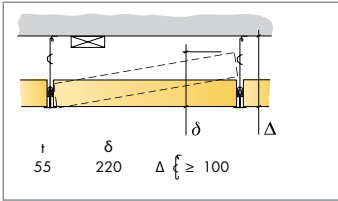

1. Combison A 600x600/1200x600

2. Connect T24 Main runner

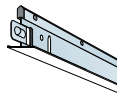

3. Connect T24 Cross tee,  
L=1200

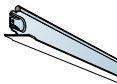

4. Connect T24 Cross tee,  
L=600

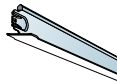

5. Connect Adjustable hanger



6. Connect Hanger clip



7. Connect Angle trim

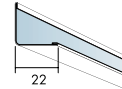

8. Combison XR (if required)  
(1500x600x50)



9. Combison Barrier (if required)  
(1200x600x40)

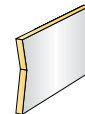

10. Connect Angle Trims position upper part of Barrier panel  
(if required)

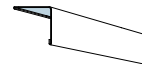

11. Connect Frieze bracket (if required)



**Ecophon**<sup>®</sup>  
SAINT-GOBAIN

---

A SOUND EFFECT ON PEOPLE

[www.ecophon.com](http://www.ecophon.com)

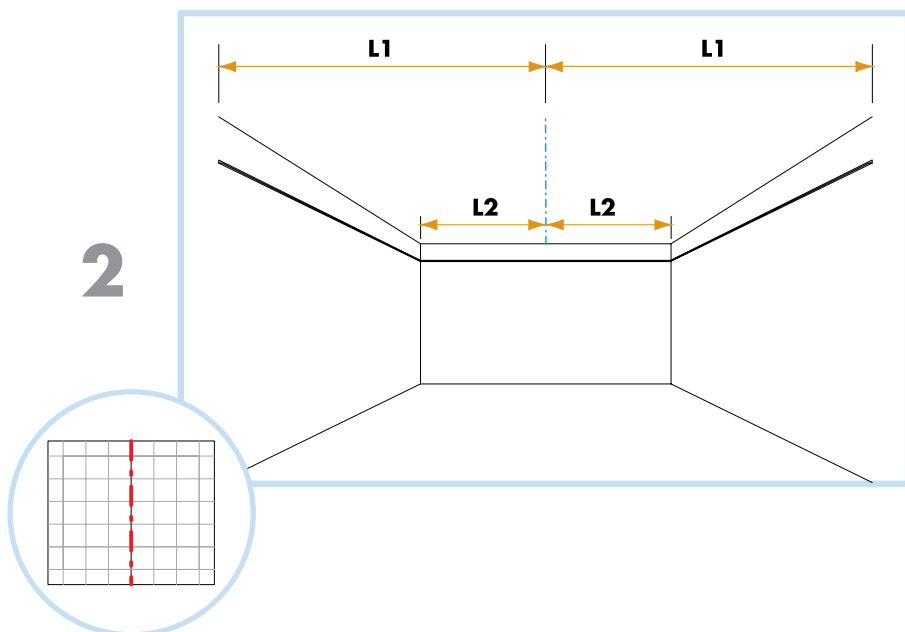
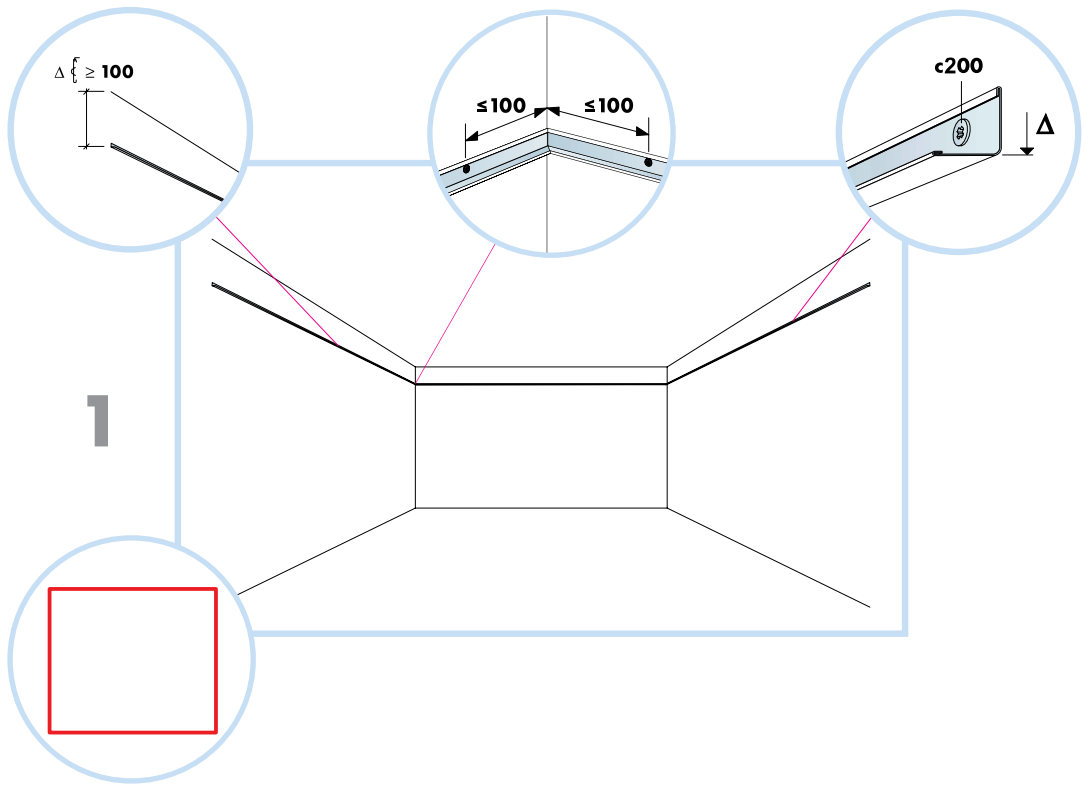

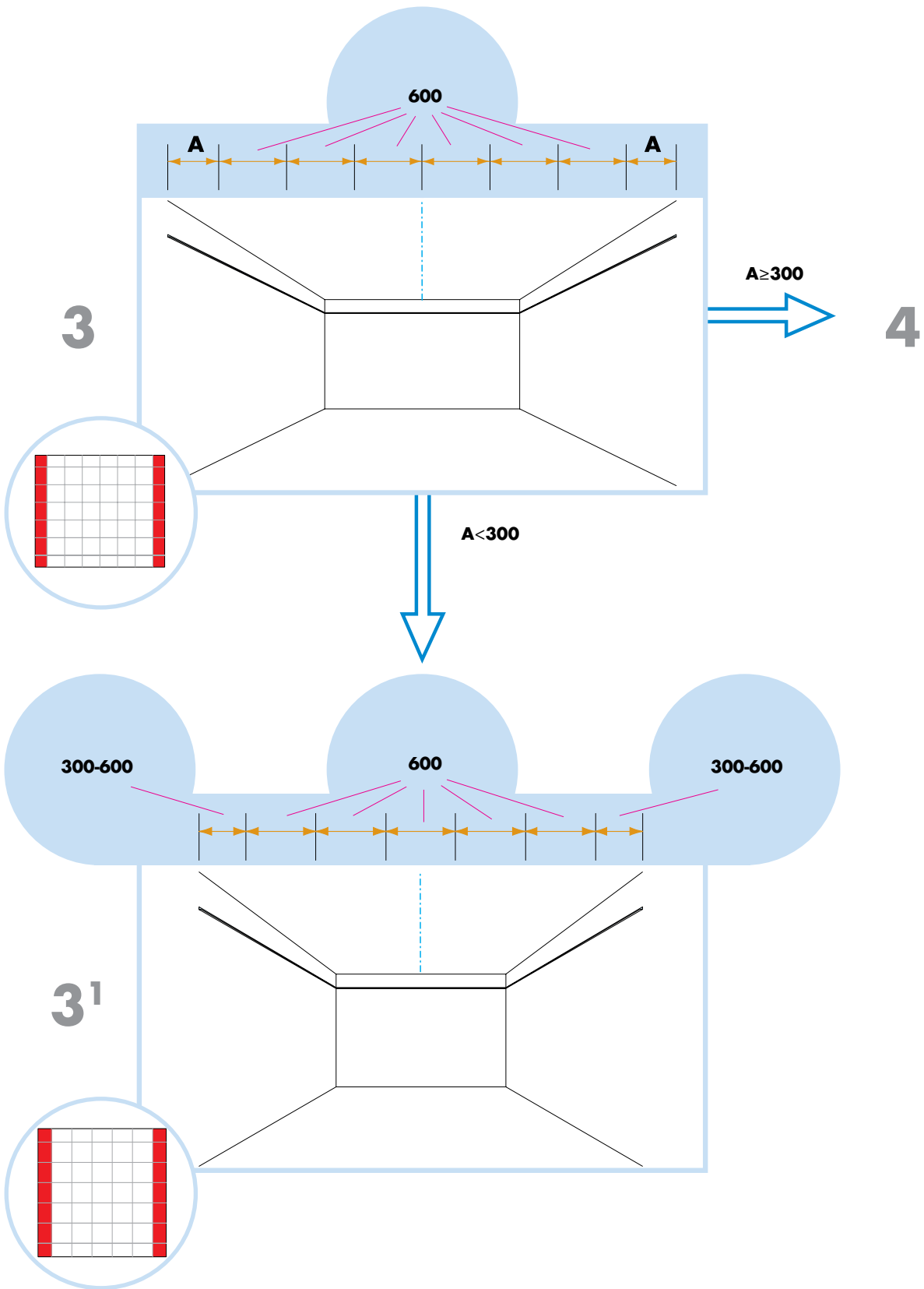

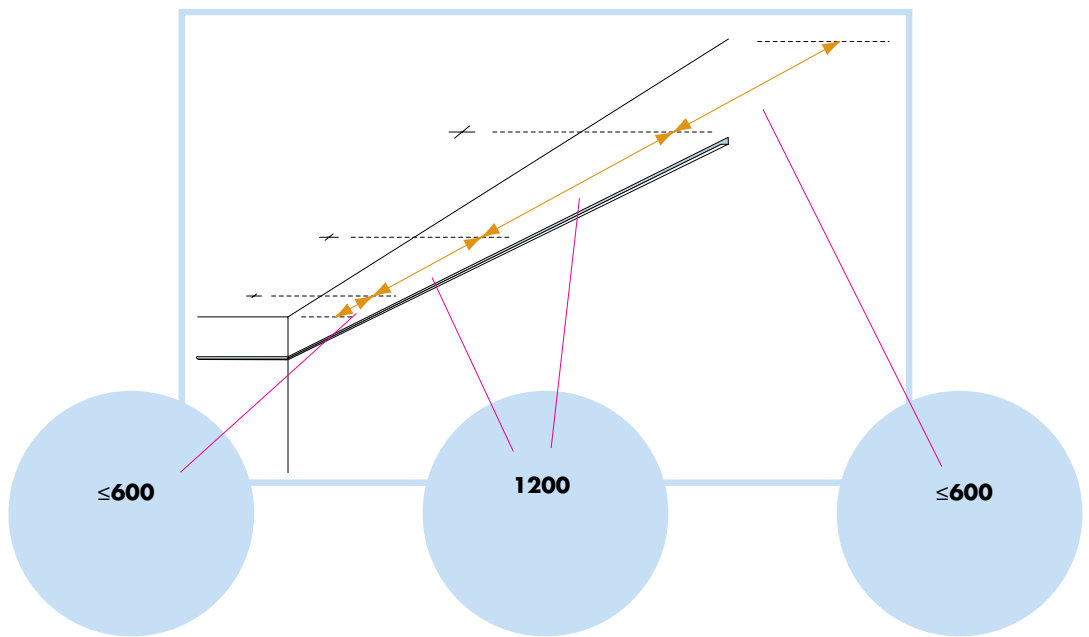
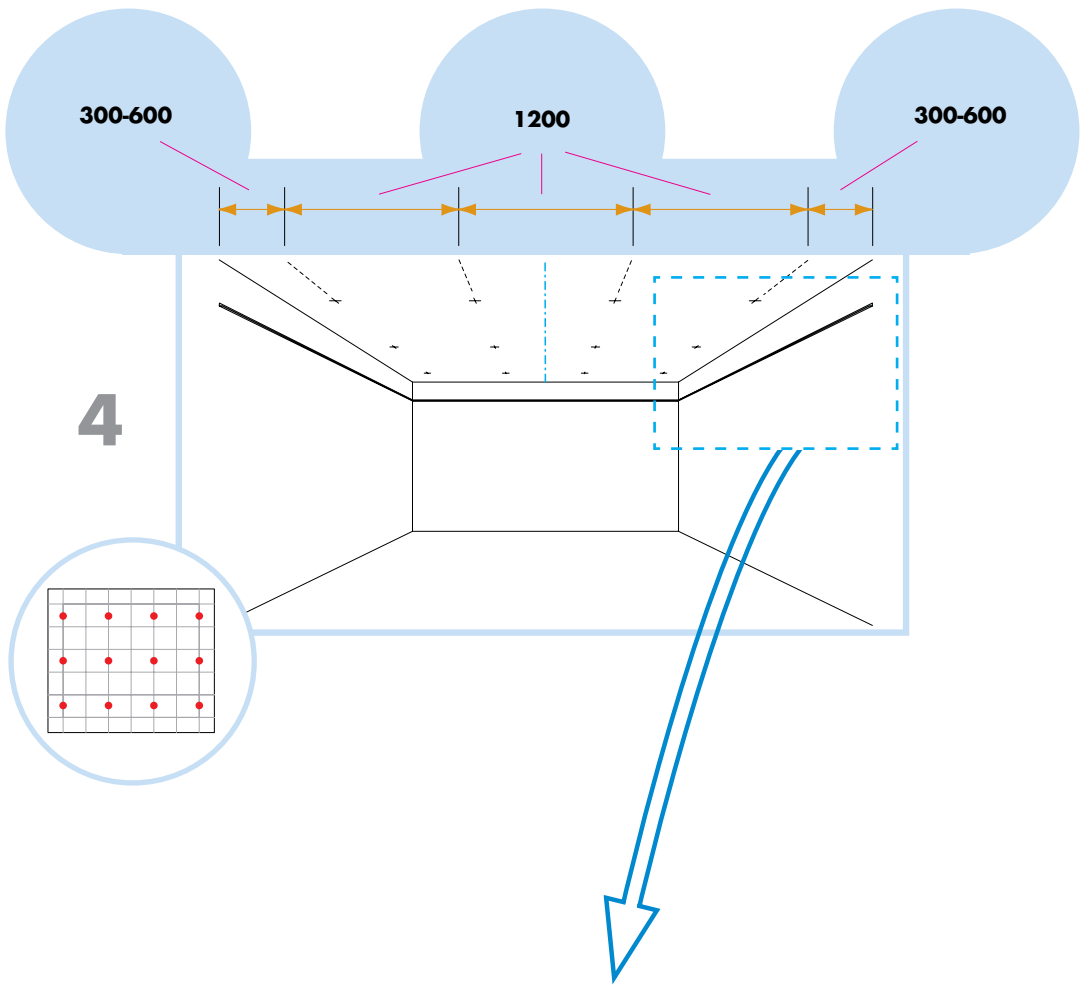

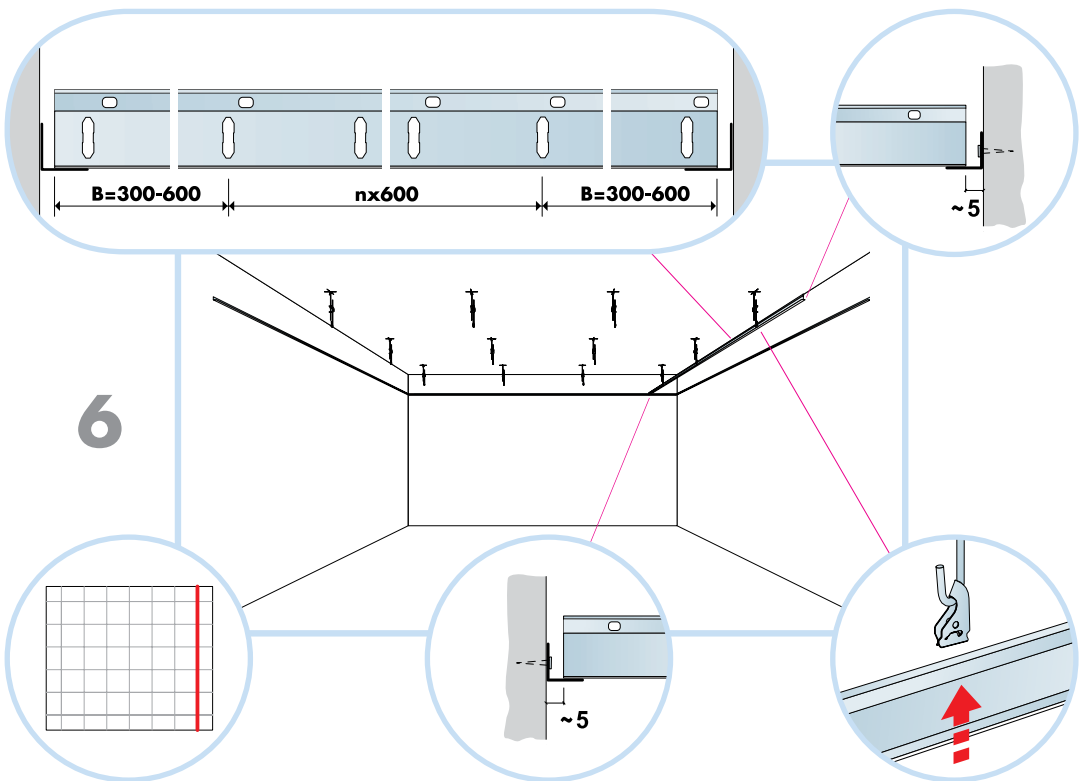
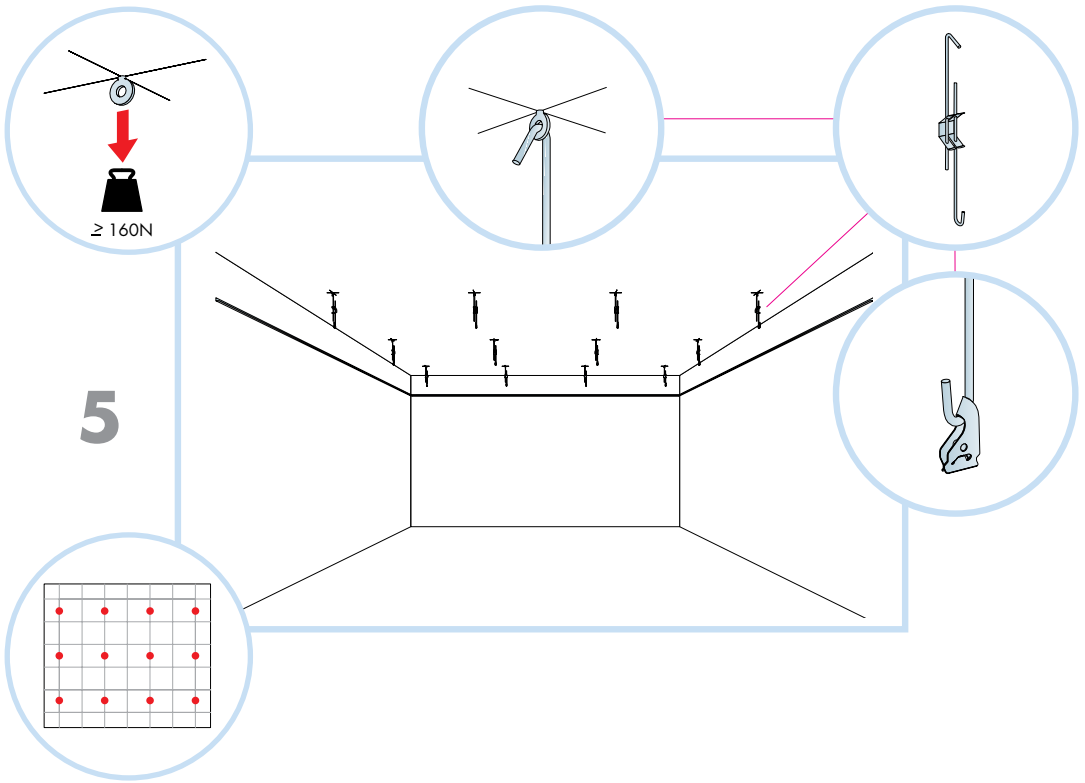

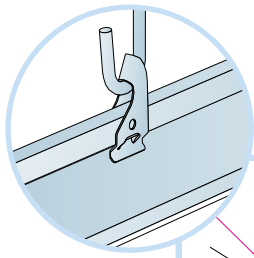

7

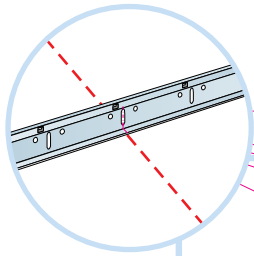
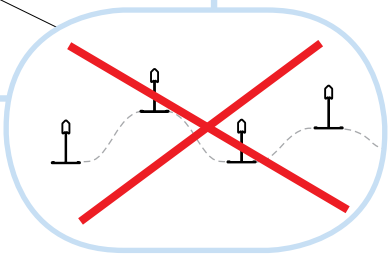
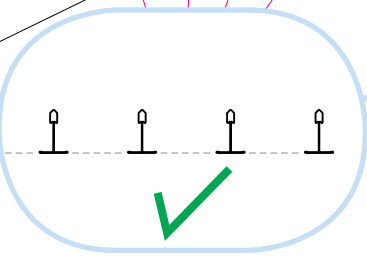
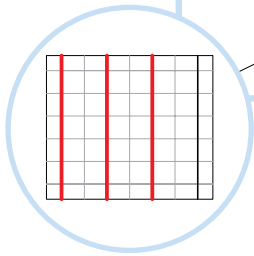
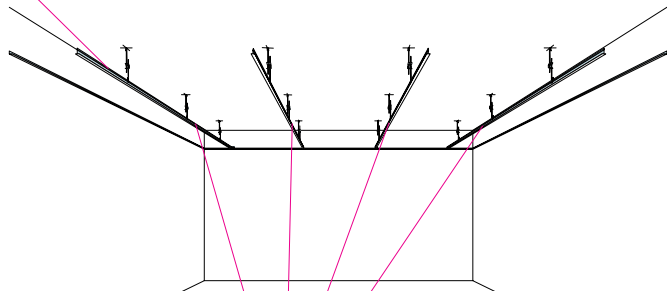

7<sub>1</sub>

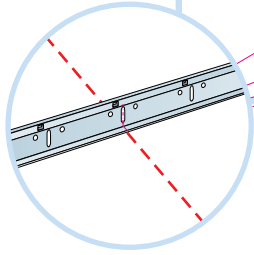
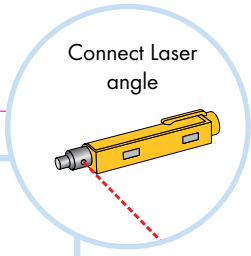
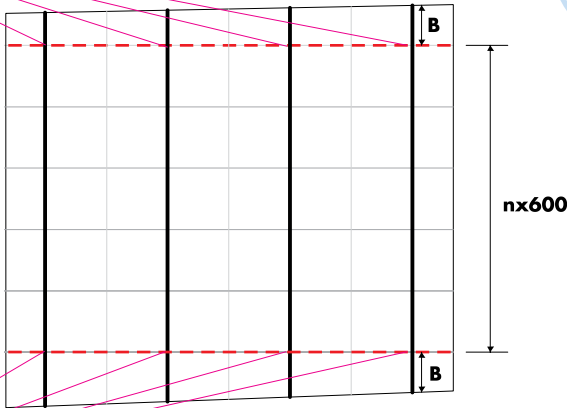

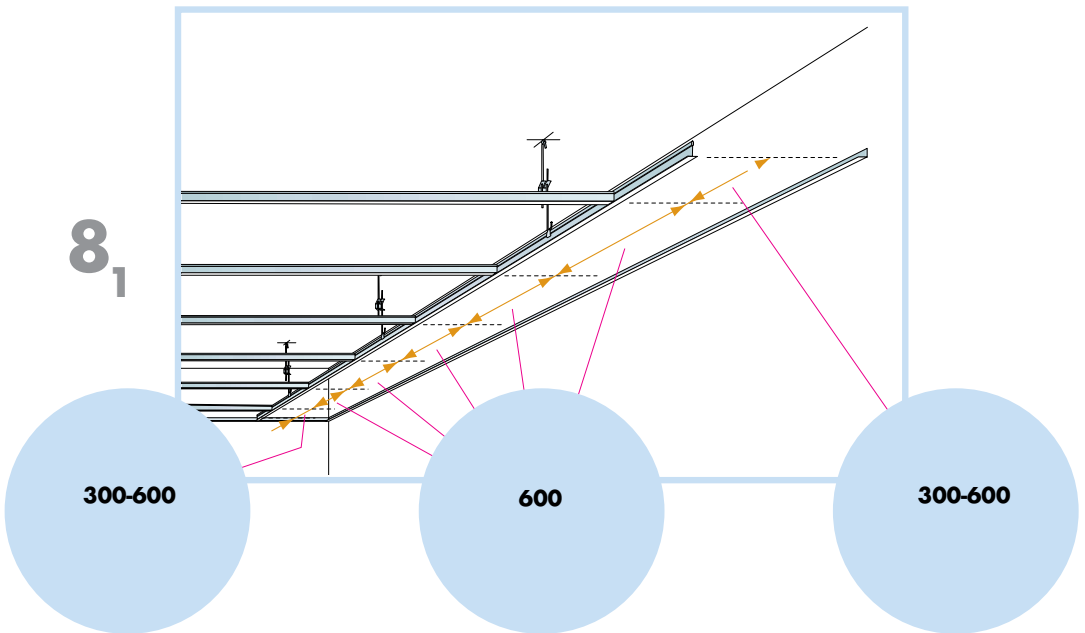
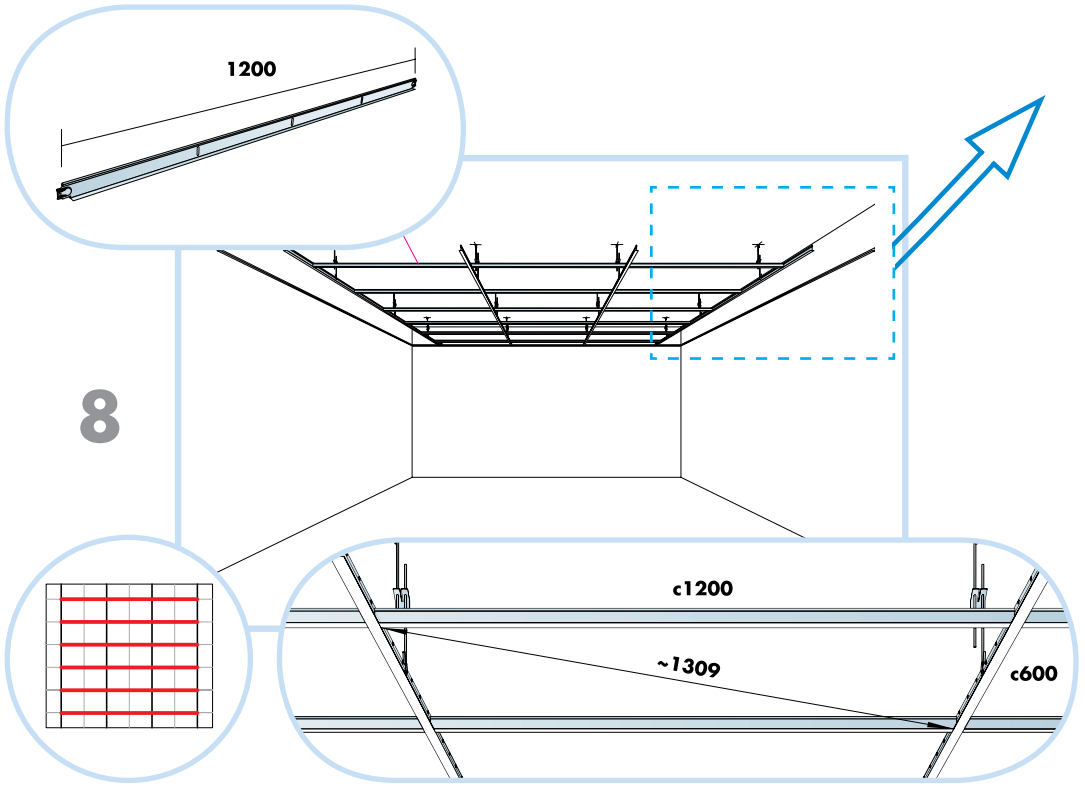



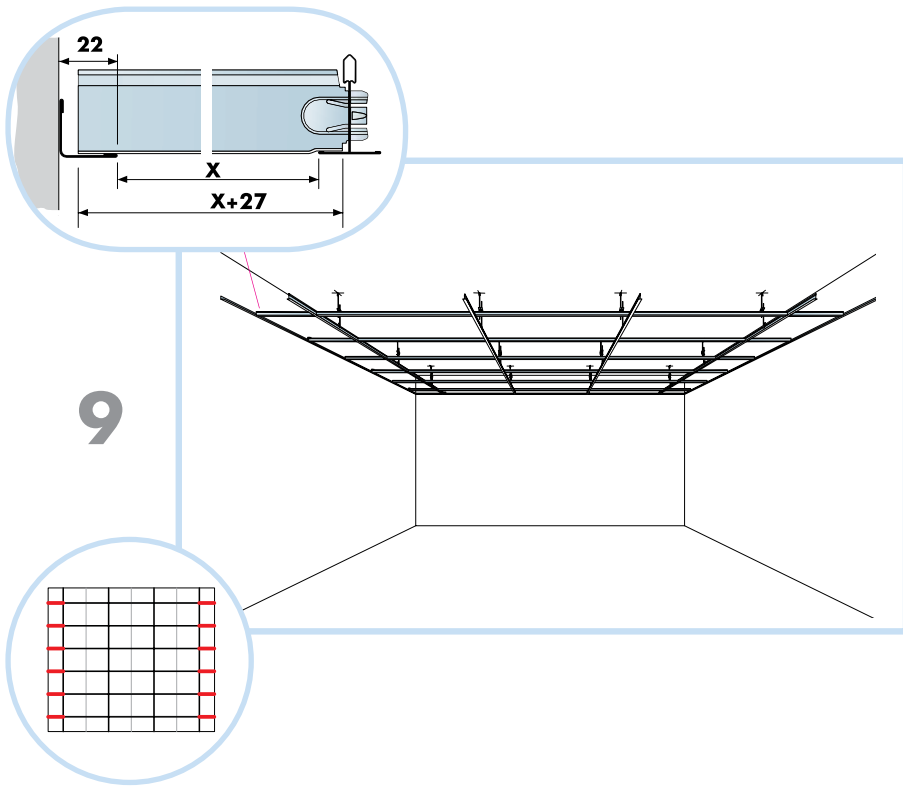

- 600x600 → 10**
- 1200x600 → 11**
- Combison Barrier x 1 → 12**
- Combison Barrier x 2 → 13**
- Combison XR → 14**

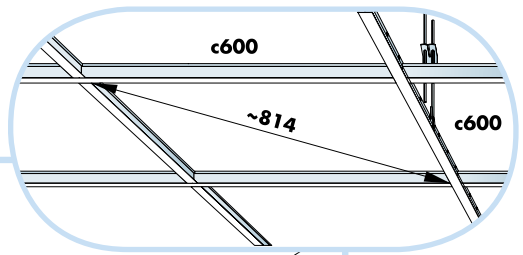
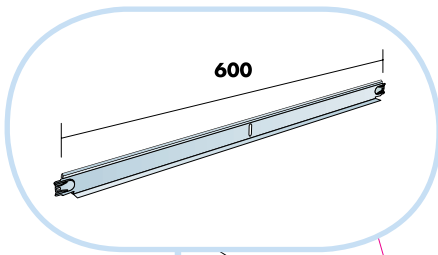

10

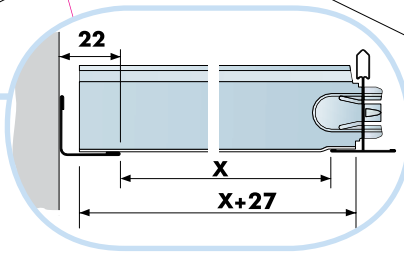
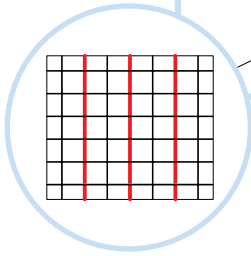
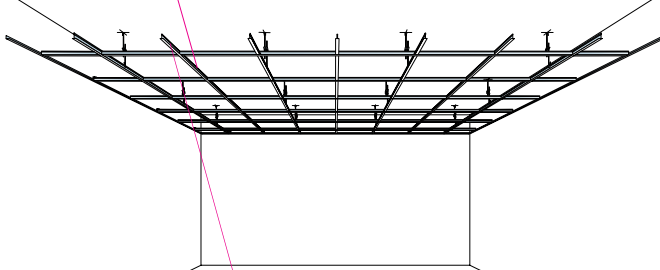

A-A

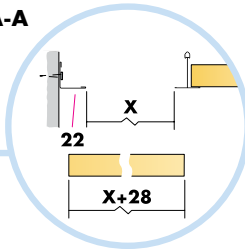

11

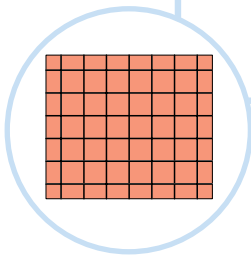
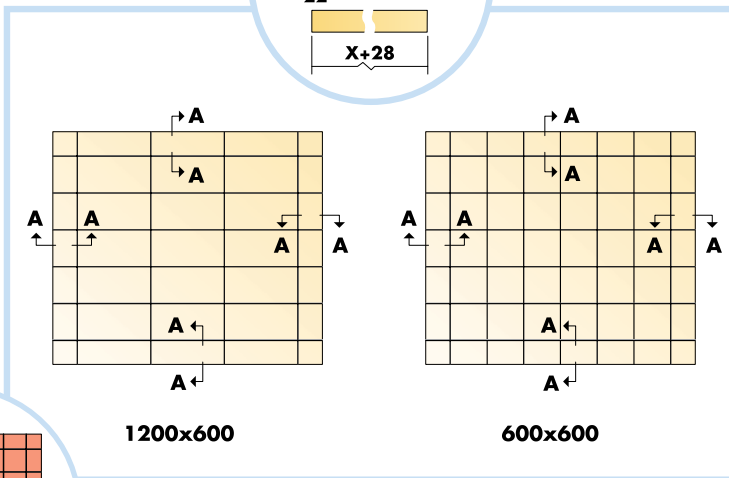

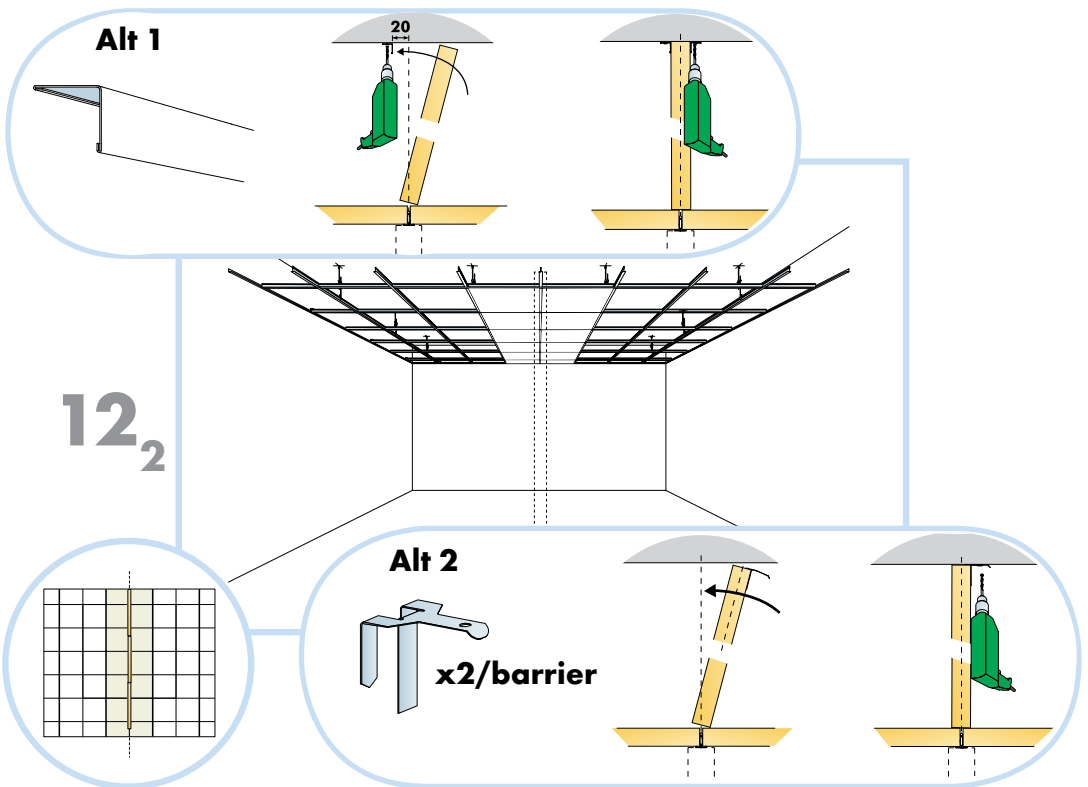
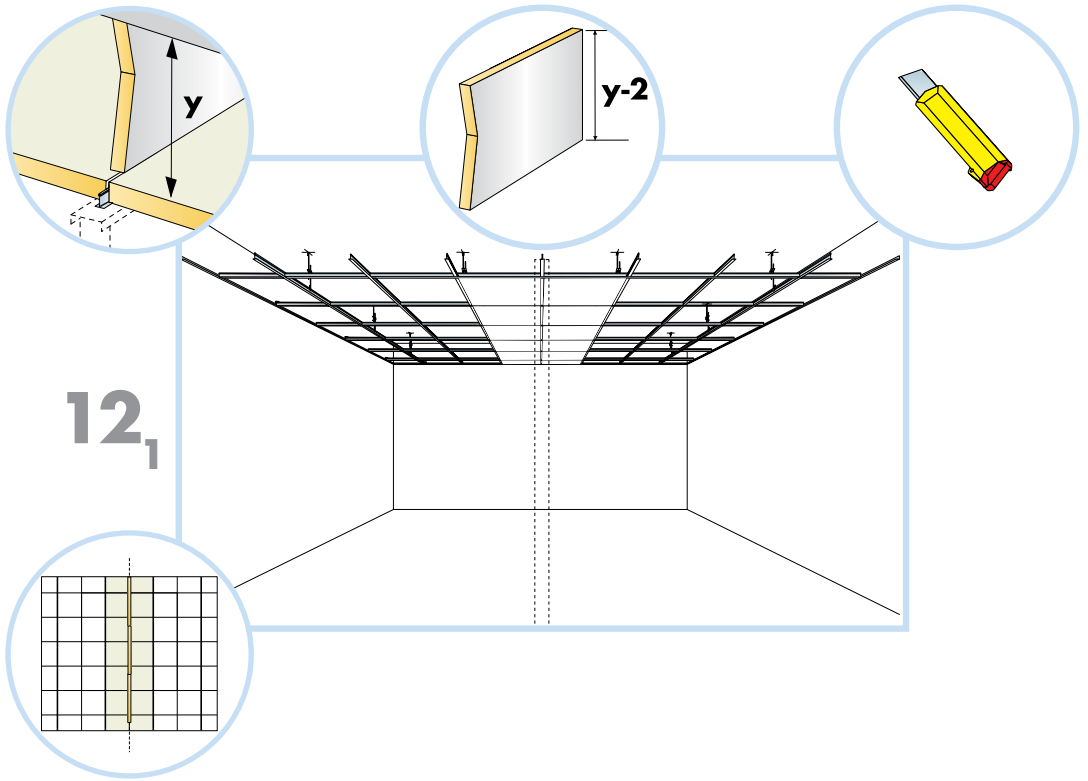

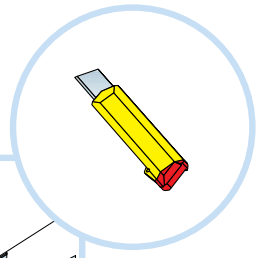
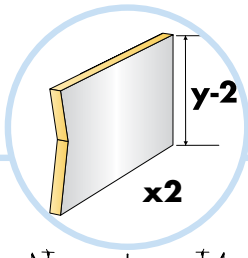
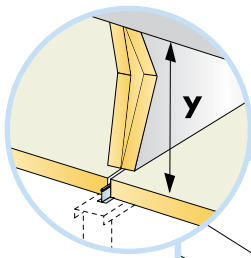

13<sub>1</sub>

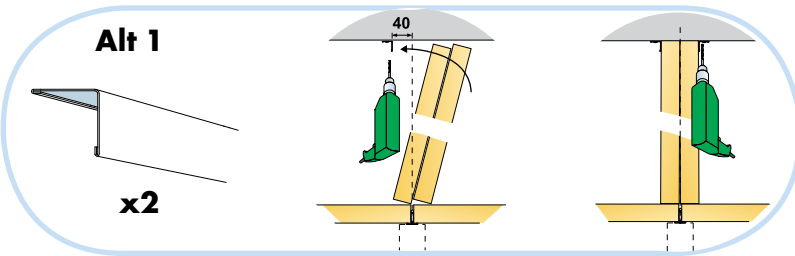
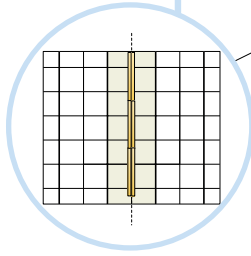
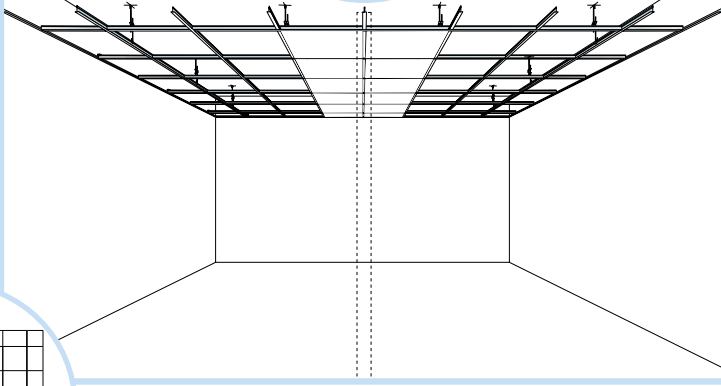

13<sub>2</sub>

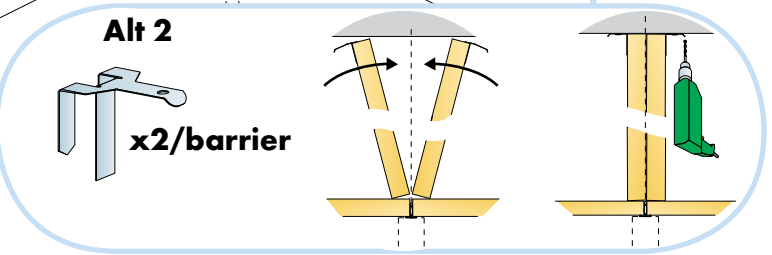
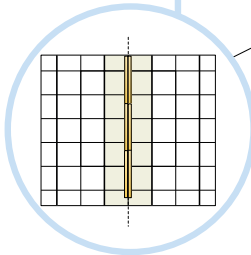
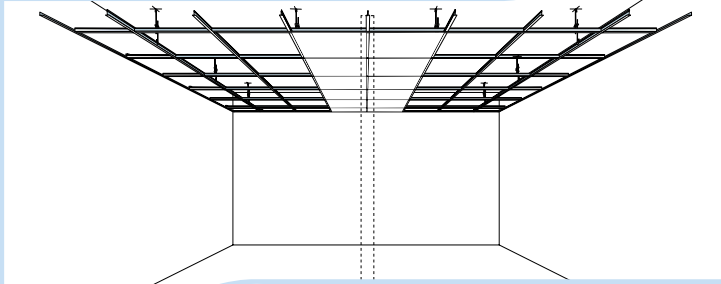

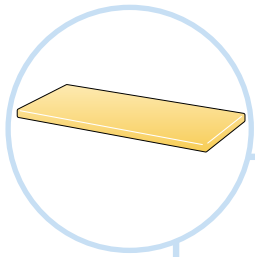

14

