

VINE

ASSEMBLY INSTRUCTIONS

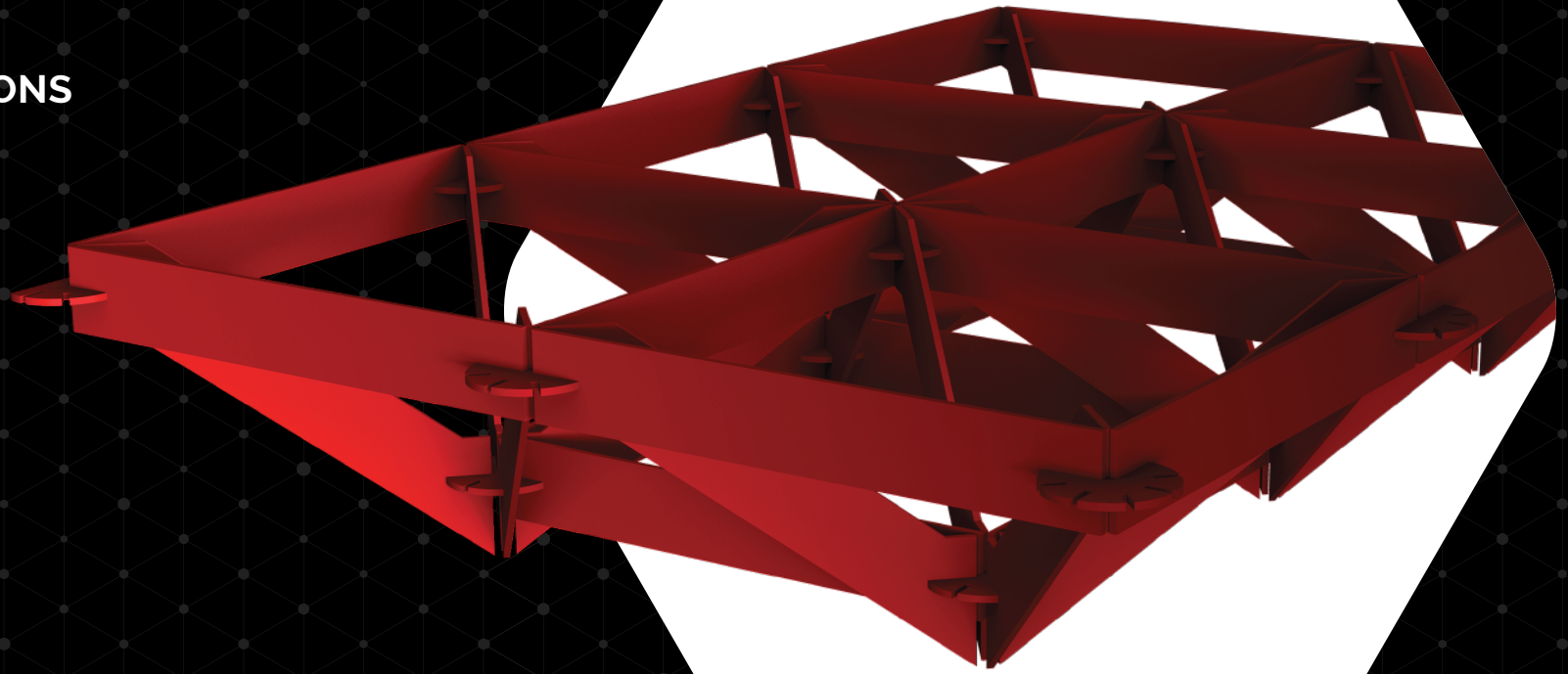

1Six8

Designers of acoustic and **environmentally sustainable** office solutions

VINE

ASSEMBLY INSTRUCTIONS

COMPONENTS

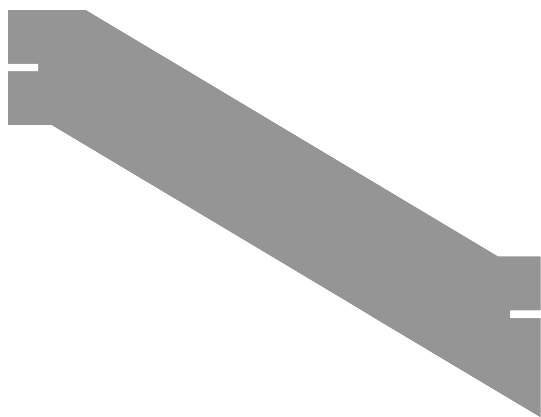

Diagonal support strut



Main frame strut

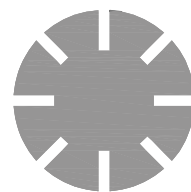

Standard 8 slot connector



Edge connector 180 degree



Edge connector 90 degree

VINE

ASSEMBLY INSTRUCTIONS

STEP 1

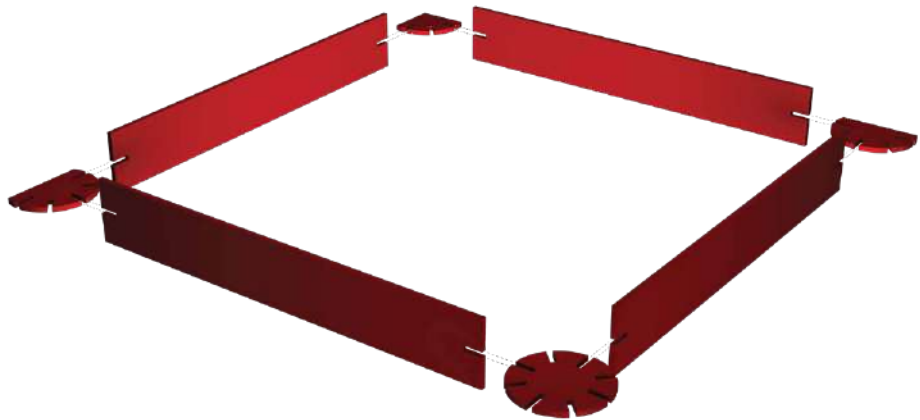

- Begin assembly from any corner of the installation using the edge connectors along the outer perimeter and standard 8 slot connectors for all inner junctions to join four main frame struts.
- Create one full, 4 sided main frame structure.

STEP 2

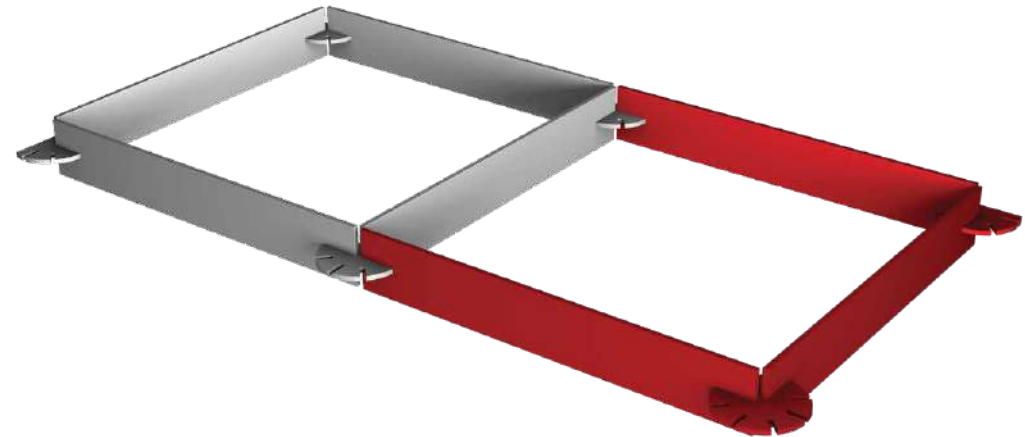

- Create a second main frame structure by joining an additional 3 main frame struts.

VINE

ASSEMBLY INSTRUCTIONS

STEP 3

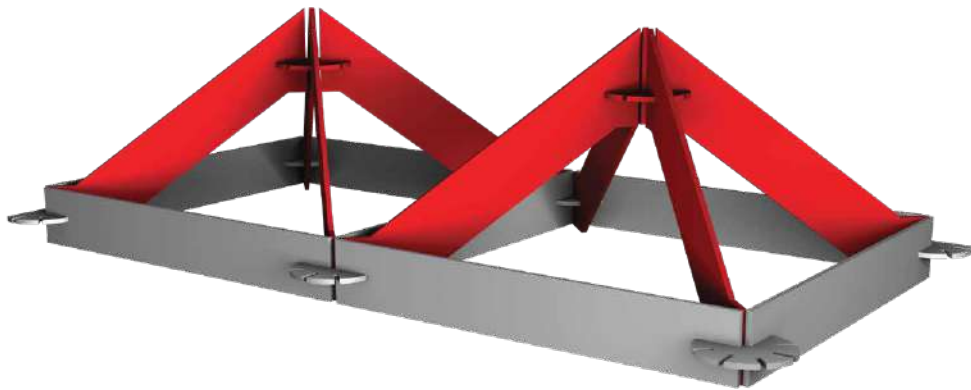

- Connect 4 diagonal supports together using a standard 8 slot round connector at their junction point and then slot in each individual diagonal arm into the corresponding slots of the main frame connectors.

STEP 4

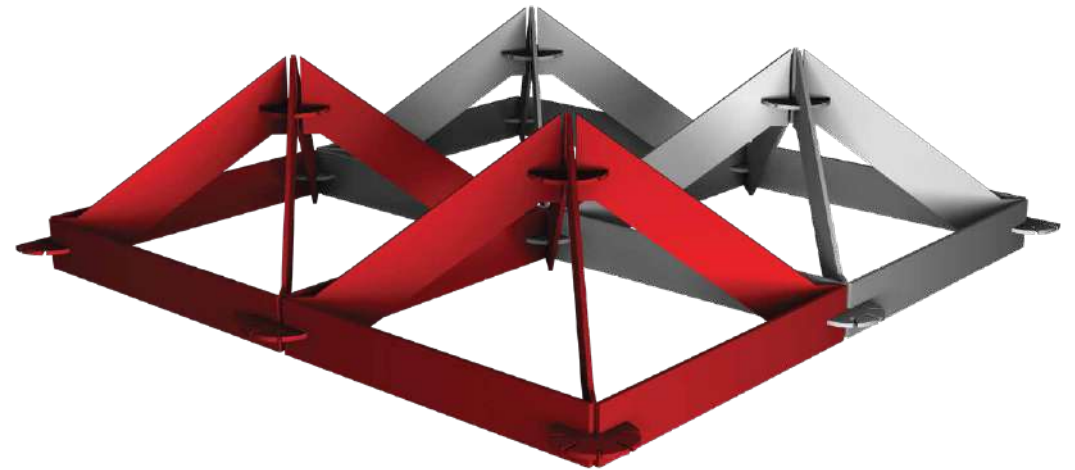

- Assemble an additional 2 main frame structures with their diagonal supports and connect together to form a 4 module system.

VINE

ASSEMBLY INSTRUCTIONS

STEP 5

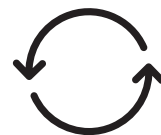
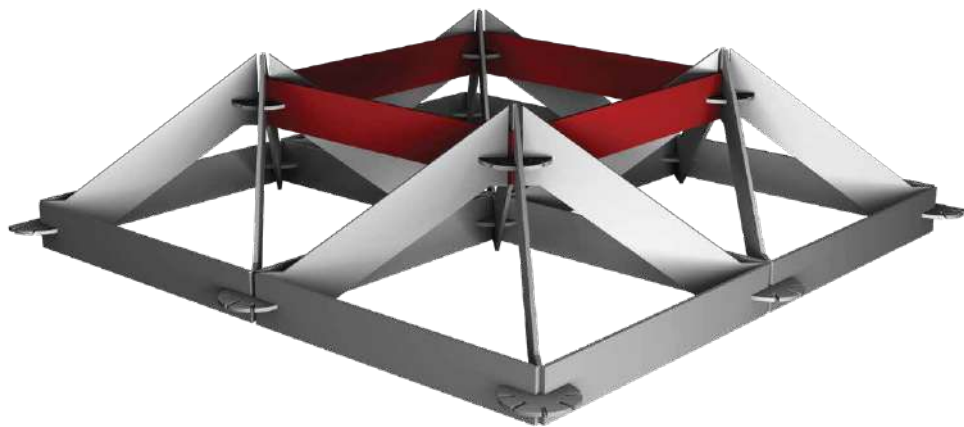

Flip over

STEP 6

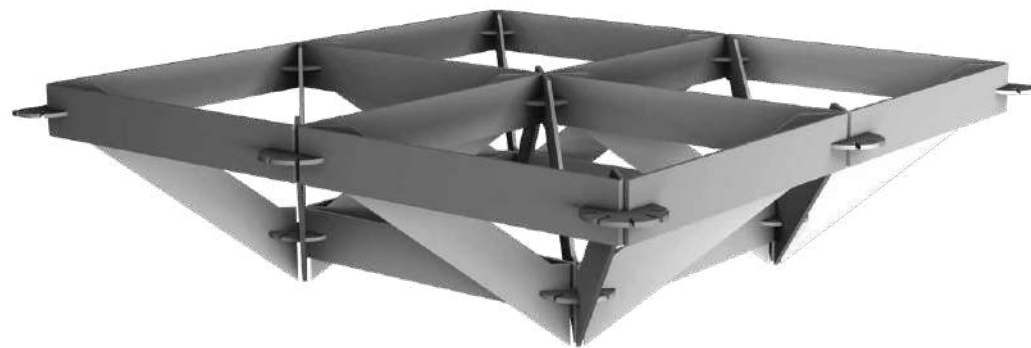

- Insert 4 main frame struts to reinforce the diagonal supports.

VINE

ASSEMBLY INSTRUCTIONS

STEP 7

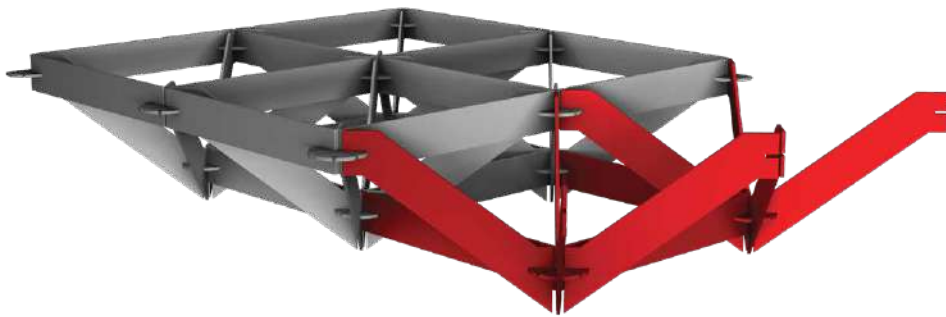

STEP 8

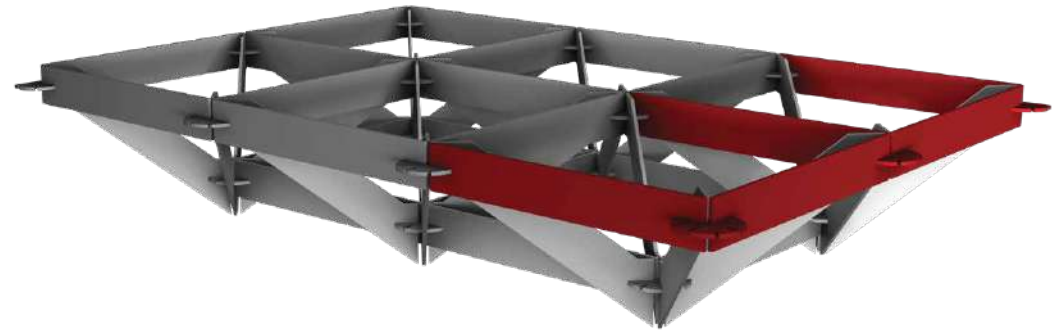

- The system can now be expanded by building up the main frame with its diagonals as seen in step 7, 8 and 9.
- Do not forget to add in the main frame struts to reinforce the diagonals as seen in step 5 as you go along.

VINE

ASSEMBLY INSTRUCTIONS

STEP 9

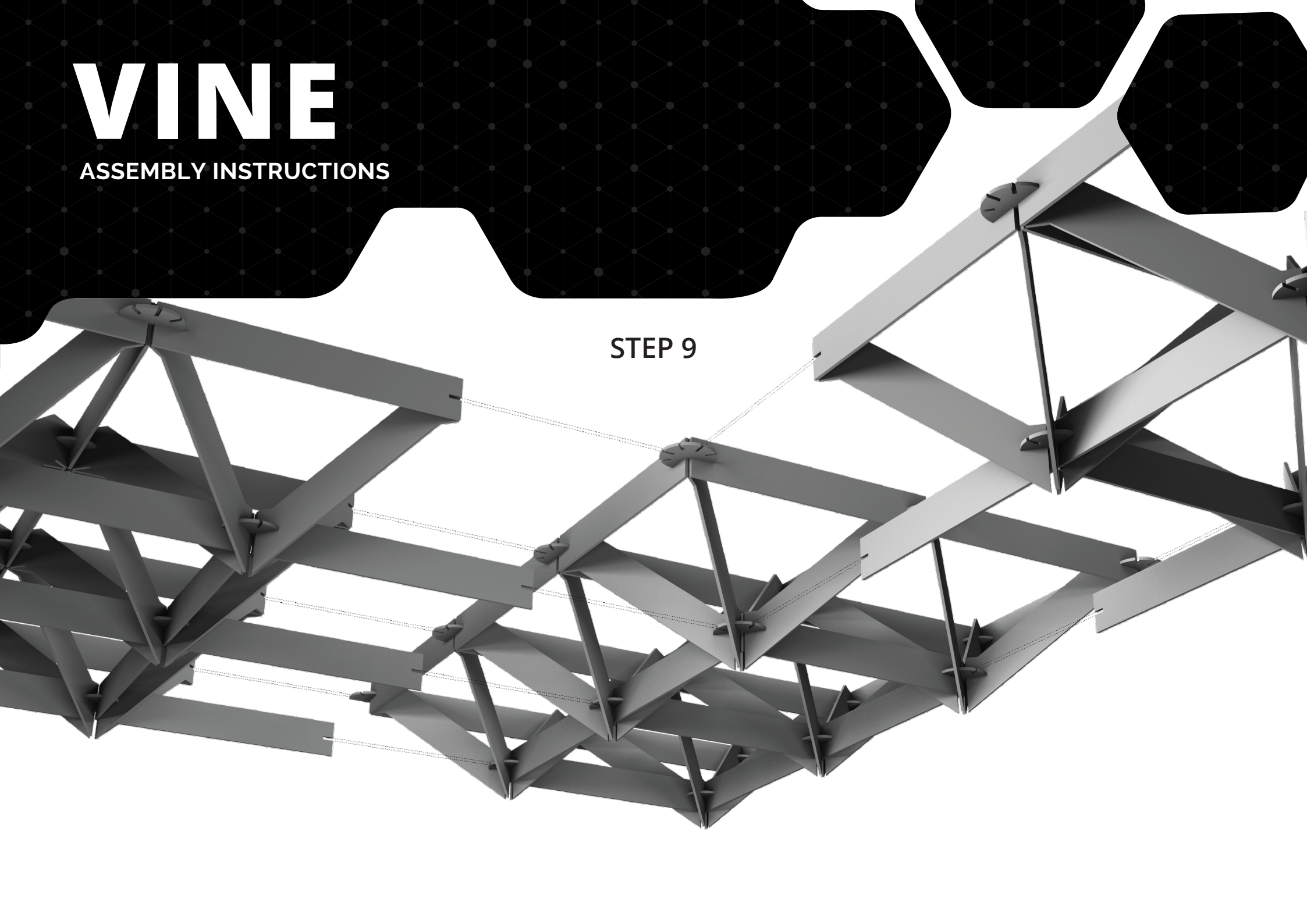

VINE

ASSEMBLY INSTRUCTIONS

 Suspension points

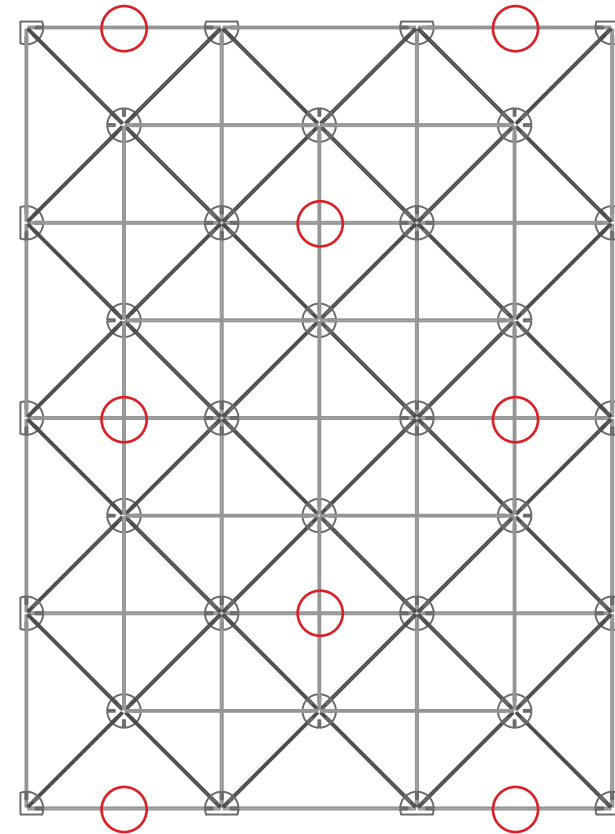
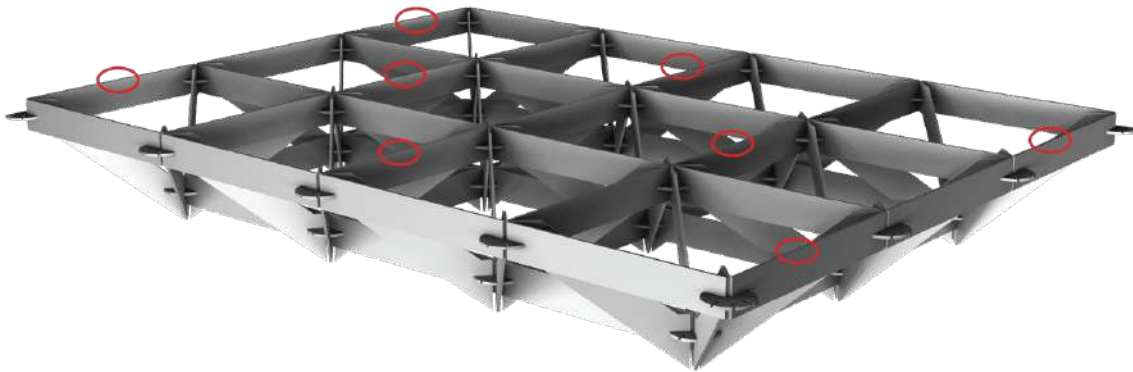

VINE

ASSEMBLY INSTRUCTIONS

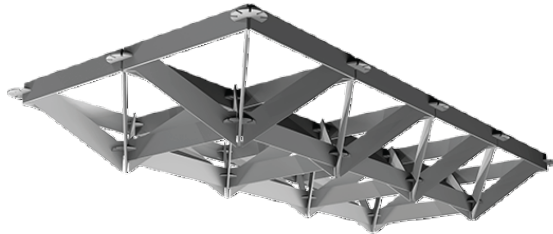

Sheet Thickness
12mm

Dimensions
1000mm (w) X 1000mm (l) modules 600 (h)

Suggested Fixings

Option 1: Direct hanging code (Clamp needs to be 12mm) with Round single hole Aluminium clip.

Option 2: Activity code with Round single hole Aluminium clip.

Option 3: 12mm Aluminium U channel with Activity code and barrel end fixing.

Direct hanging code

Round single hole Aluminum clip

Activity code

Round single hole Aluminum clip



14six8

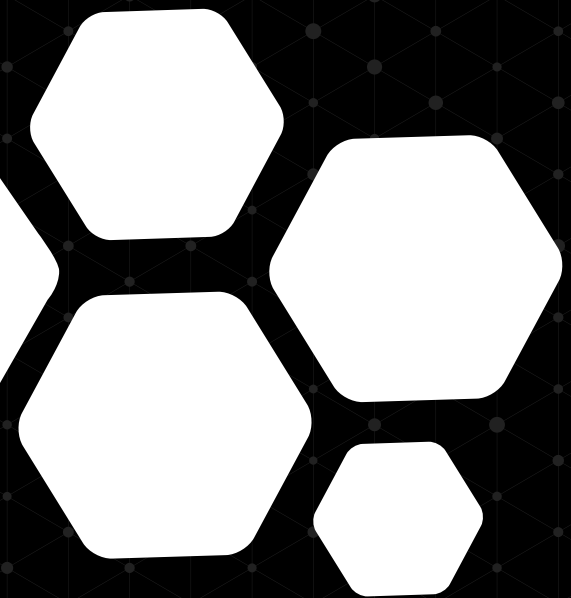

Telephone

Francois: +44 7305 349443

Daniel: +27 82 331 8319

Email

studio@14six8.com

Website

www.14six8.com

Address

71-75, Shelton Street, Covent Garden,
London, WC2H 9JQ, United Kingdom

VINE

ASSEMBLY INSTRUCTIONS