BuzziLoose

Product Specification Sheet

This document contains technical information about the BuzziLoose







www.buzzi.space

Sound absorbing hanging panel

Large office spaces or residential lofts often echo. This is an irritating problem which does little to encourage hard work or make a space cosy. BuzziSpace has developed the BuzziLoose: stick it to the ceiling to dampen sounds without losing out on chic design

Design by BuzziSpace Studio

General

-  BuzziLoose
Flat or 3D
-  Flat version: honeycomb cardboard + felt
3D version: honeycomb cardboard + MDF + acoustic foam + fabric
- Flat: BuzziFelt or covered with extra layer of Fabric, Trevira CS+, Trevira CS, Revive 1, Clara 2, Remix 3, Hero 2, Tonus 4, Memory 2
-  3D: Fabric, Trevira CS+, Trevira CS, Revive 1, Clara 2, Remix 3, Hero 2, Tonus 4, Memory 2
MonoColor or MultiColor
Black Cables or Alu Cables 2 or 5 m | 78.74 or 196.85"
-  If installing on suspended ceiling, verify load capacity prior to installation.

Certifications



Flat



3D

Acoustics



Attenuation



Mid tone



High tone

Content

Configurations	3	Fixing System	8
Pattern	4	Dimensions	9
Fabrics	5	Acoustics	10

Configurations

BuzziLoose

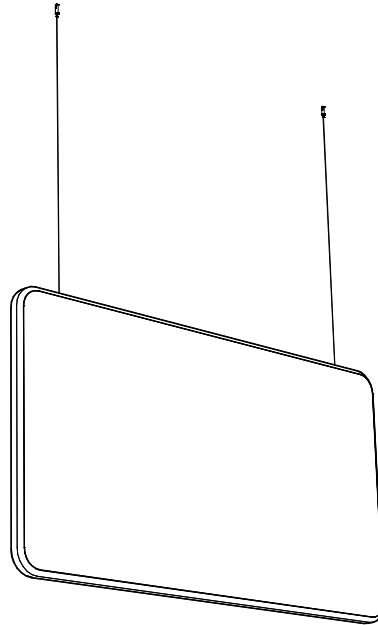

 BuzziLoose
Flat or 3D

 Flat version: honeycomb cardboard + felt
3D version: honeycomb cardboard + MDF + acoustic foam + fabric

	Flat: XS: W 80 cm H 60 cm D 2,7 cm	3D: XS: W 80 cm H 60 cm D 6 cm
	W 31.50" H 23.62" D 1.06"	W 31.50" H 23.62" D 2.36"
	S: W 120 cm H 80 cm D 2,7 cm	S: W 120 cm H 80 cm D 6 cm
	W 47.24" H 31.50" D 1.06"	W 47.24" H 31.50" D 2.36"
	M: W 160 cm H 80 cm D 2,7 cm	M: W 160 cm H 80 cm D 6 cm
	W 62.99" H 31.50" D 1.06"	W 62.99" H 31.50" D 2.36"
	L: W 180 cm H 100 cm D 2,7 cm	L: W 180 cm H 100 cm D 6 cm
	W 70.87" H 39.37" D 1.06"	W 70.87" H 39.37" D 2.36"
	XL: W 200 cm H 120 cm D 2,7 cm	XL: W 200 cm H 120 cm D 6 cm
	W 78.74" H 47.24" D 1.06"	W 78.74" H 47.24" D 2.36"

	Flat: XS: 1,6 kg 3.53 lbs	3D: XS: 3,7 kg 8.16 lbs
	S: 3,5 kg 7.72 lbs	S: 6,7 kg 14.77 lbs
	M: 4,6 kg 10.14 lbs	M: 8,3 kg 18.30 lbs
	L: 6,6 kg 14.55 lbs	L: 10,9 kg 24.03 lbs
	XL: 8,3 kg 18.30 lbs	XL: 13,7 kg 30.20 lbs

Flat: BuzziFelt or covered with extra layer of Fabric, Trevira CS+, Trevira CS, Revive 1, Clara 2, Remix 3, Hero 2, Tonus 4, Memory 2

... 3D: Fabric, Trevira CS+, Trevira CS, Revive 1, Clara 2, Remix 3, Hero 2, Tonus 4, Memory 2
MonoColor or MultiColor
Black Cables or Alu Cables 2 or 5 m | 78.74 or 196.85"

 If installing on suspended ceiling, verify load capacity prior to installation.

Pattern

Flat



- Always stitch
- Felt
- Covered with extra layer fabric

3D



- Never stitch
- Fabric

Fabrics

Felt (Only for Flat) (12 colors)

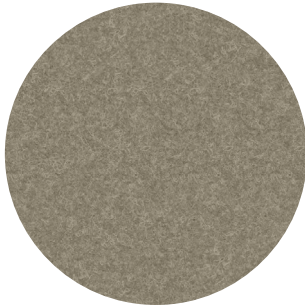

Composition 100% Recycled PE.T. Felt, latex backing
Weight 1.000 g/m² | 29.49 oz/yd²
Abrasion resistance >7.000 Martindale
Flammability EU: EN 13501.1 + A1/2009 Class B-s1,d0
USA: ASTM E84 Class A certified
Fastness to light USA 5



Fabric (45 colors)

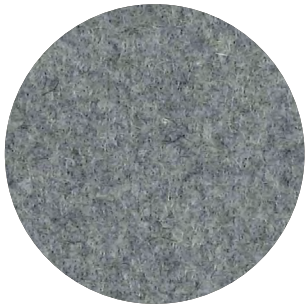

Category A
Composition 70% Recycled Wool, 25% Recycled Polyacryl,
5% Recycled Other Fabrics
Weight 405 g/m² | 11.94 oz/yd²
Abrasion resistance 40.000 Martindale, 50,000 Wyzenbeek
Flammability EU: EN 1021.1/2006 | BS EN 1021.1/2006 (cigarette).
EN 1021.2/2006 | BS EN 1021.2/2006 (match)
USA: CAL TB 117 | ASTM E84 CLASS A
Fastness to light EU: 4 | USA 4
Fastness to rubbing EU: Wet 3-4 | Dry 4-5
Fastness to crocking USA: Wet 5 | Dry 5



Trevira CS+ | CS (47 colors)

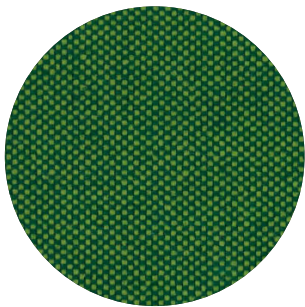

Category A
Weight 420 g/m² | 12.39 oz/yd²
Composition 100% Polyester, Trevira CS
Abrasion resistance 100.000 Martindale, 90,000 Wyzenbeek
Flammability BS 5852 part II: CRIB 5 | BS 7176 Medium Hazard
USA: CAL TB 117 | M1 | B1 | EN 1021/1-2 | C1 |
IMO Res. A652 (16)
Fastness to light EU: 6 | USA 5
Fastness to rubbing EU: Wet 4-5 | Dry 4-5
Fastness to crocking USA: Wet 5 | Dry 5



Revive 1 (25 colors)

kvadrat

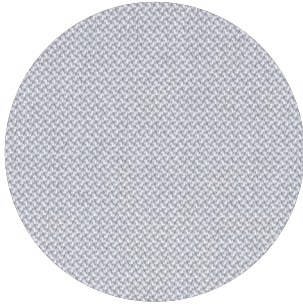

Category A

Composition 100% recycled polyester FR

Weight 430 g/lin.m

Abrasion resistance 60.000 Martindale rubs, EN ISO 12947

Flammability EN 1021-1/2 | DIN 4102 B1 | Önorm B1/Q1
UNI 9175 1IM | US Cal. Tech. Bull. 117
IMO A.652 (16)

Fastness to light Note 5-7, ISO 105-B02

Fastness to rubbing (ISO) dry 5, wet 4-5

Pilling Note 4-5, EN ISO 12945



Clara 2 (24 colors)

kvadrat

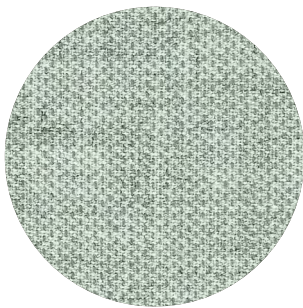

Category B

Composition 92% new wool, 8% nylon

Weight 400 g/lin.m

Abrasion resistance 80.000 Martindale rubs, EN ISO 12947

Flammability EN 1021-1/2 | BS 5852, ignition source 2-3 | DIN 4102 B2
NF D 60 013 | UNI 9175 1IM | US Cal. Tech. Bull. 117, Sec. E
NFPA 260 | IMO A.652(16)

Fastness to light Note 5-7, ISO 105-B02

Fastness to rubbing (ISO) dry 4-5, wet 4

Pilling Note 4, EN ISO 12945



Remix 3 (73 colors)

kvadrat



Category B

Composition 90% new wool, 10% nylon

Weight 415 g/lin.m

Abrasion resistance 100.000 Martindale rubs, EN ISO 12947

Flammability EN 1021-1/2 | BS 5852 part 1
Önorm B1/Q1 | NF D 60 013 | UNI 9175, 1IM
AS/NZS 1530.3 | Cal. Tech. Bull. 117-2013
NFPA 260 | IMO FTP Code 2010:Part 8

Fastness to light Note 5-7, ISO 105-B02

Fastness to rubbing (ISO) dry 4-5, wet 4

Pilling Note 4, EN ISO 12945



Hero 2 (33 colors)

kvadrat

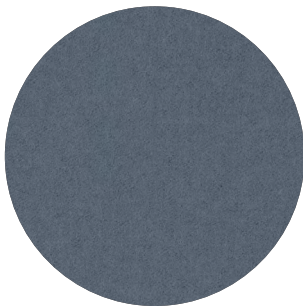

Category C

Composition 97% new wool, 3% nylon

Weight 580 g/lin.m

Abrasion resistance 45.000 Martindale rubs, EN ISO 12947

Flammability EN 1021-1/2 | DIN 4102 B2 | NF D 60 013
UNI 9175 1IM | US Cal. Bull. 117-2013 | NFPA 260
IMO A.652 (16)

Fastness to light Note 5-6, ISO 105-B02

Fastness to rubbing (ISO) dry 4-5, wet 4-5

Pilling Note 3-4, EN ISO 12945



Tonus 4 (47 colors)

kvadrat



Category D

Composition 90% new wool, 10% Helanca

Weight 665 g/lin.m

Abrasion resistance 100.000 Martindale rubs, EN ISO 12947

Flammability EN 1021-1/2 | BS 5852 part 1 | DIN 4102 B2

Önorm B1/Q1 | NF D 60 013 | UNI 9175 11M

US Cal. Bull. 117-2013 | NFPA 260 | IMO A.652 (16)

Fastness to light Note 5-7, ISO 105-B02

Fastness to rubbing (ISO) dry 3-5, wet 3-5

Pilling Note 3, EN ISO 12945



Memory 2 (20 colors)

kvadrat

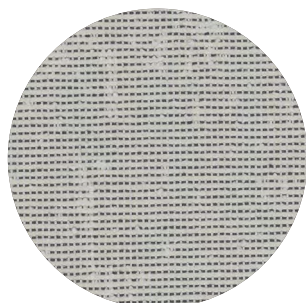

Category E

Composition 100% Trevira CS

Weight 700 g/lin.m

Abrasion resistance

35.000 rubs acc. to the Martindale method, EN ISO 12947

Flammability EN 1021-1/2 | DIN 4102 B1 | Önorm B1/Q1

NF D 60 013 | NF P 92 507 M1 | UNI 9175 11M

UNI 9177 classe 1 | US Cal. Tech. Bull. 117

IMO A.652 (16)

Fastness to light Note 5-8, ISO 105-B02

Fastness to rubbing (ISO) dry 4-5, wet 4-5

Pilling Note 4, EN ISO 12945



Fixing System

BuzziLoose

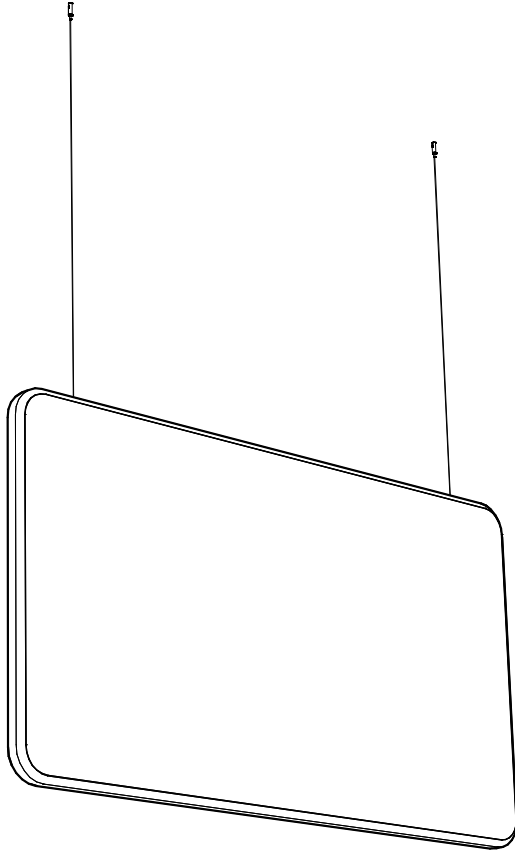

- Cable L 2 m | 5 m Ø 1,5 mm incorporated in BuzziLoose
- Color Cable: aluminium or black
- 2x fasteners and ceiling screws included

Dimensions

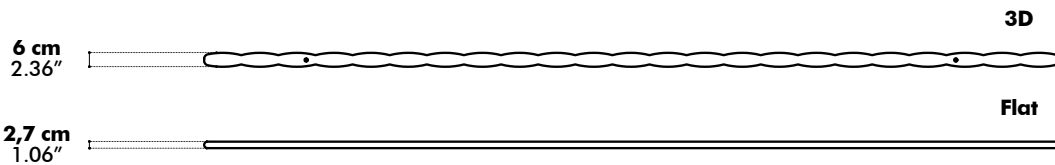
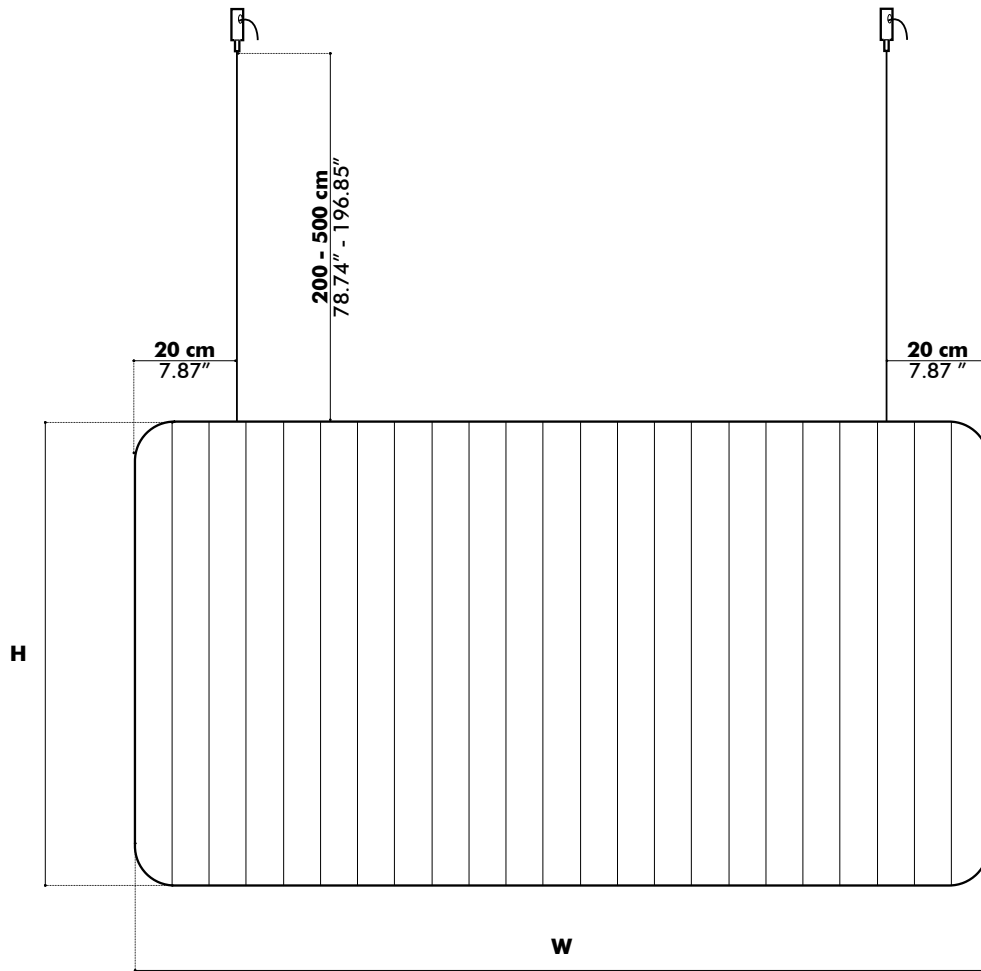

	XS	S	M	L	XL
W	80 cm 31.50"	120 cm 47.24"	160 cm 62.99"	180 cm 70.87"	200 cm 78.74"
H	60 cm 23.62"	80 cm 31.50"	80 cm 31.50"	100 cm 39.37"	120 cm 47.24"

Acoustics

BuzziLoose Flat

Equivalent sound absorption area in m² per object

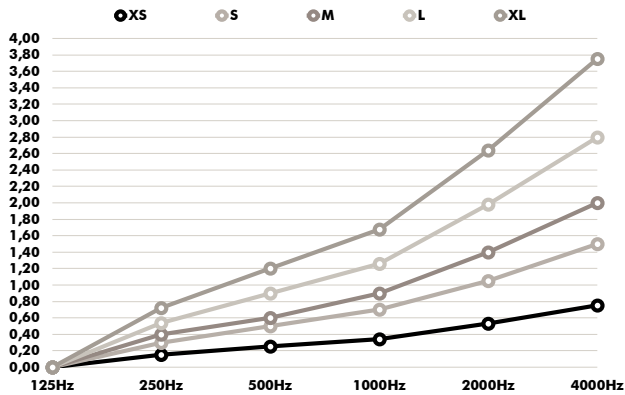

Hz	XS Aeq/m ²	S Aeq/m ²	M Aeq/m ²	L Aeq/m ²	XL Aeq/m ²
125	0.00	0.00	0.00	0.00	0.00
250	0.15	0.30	0.40	0.54	0.72
500	0.25	0.50	0.60	0.90	1.20
1000	0.34	0.70	0.90	1.26	1.68
2000	0.53	1.05	1.40	1.98	2.64
4000	0.75	1.50	2.00	2.80	3.75

BuzziLoose 3D

Equivalent sound absorption area in m² per object

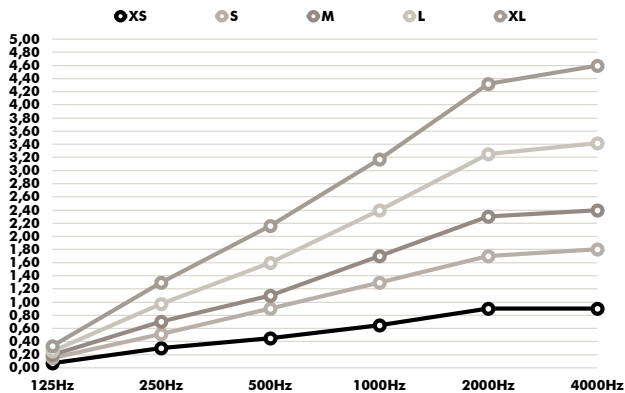

Hz	XS Aeq/m ²	S Aeq/m ²	M Aeq/m ²	L Aeq/m ²	XL Aeq/m ²
125	0.07	0.15	0.20	0.25	0.33
250	0.30	0.51	0.70	0.97	1.30
500	0.45	0.90	1.10	1.60	2.16
1000	0.65	1.30	1.70	2.40	3.17
2000	0.90	1.70	2.30	3.25	4.32
4000	0.90	1.80	2.40	3.42	4.60