BuzziZepp

Product Specification Sheet

This document contains technical information about the BuzziZepp







www.buzzi.space

A suspended, linear acoustic panel

BuzziZepp is an impressive, sound absorbing panel offering acoustic treatment to a space. The suspended design was conceived by designer Alain Gilles as an “imaginary island” to visually delineate and bring a sense of tranquility to large open spaces. With its striking linear design, BuzziZepp hovers from above to define zones without obstruction, establishing a more intimate, quiet and purposeful sense of space—no vertical partitions or walls needed! The slim framework is made of upholstered acoustic panels, engineered to absorb sound and reduce echo.

Design by Alain Gilles and BuzziSpace Studio

General

-  Ceiling suspended
Small | Medium
-  Upholstered acoustic panel
-  IP20 Dry usage
-  Flat packed
-  The product must be suspended on a solid structure or ceiling, taking into account the weight of the product and the local regulation.

Certifications



Acoustics



Content

Configurations	3
Fixing System	4
Fabrics	5
Dimensions	8
Acoustics	10

Configurations

BuzziZepp Small

- Core: Poplar multiplex
- 🌲 Filling: acoustic foam
- Cover: upholstered in fabric
- ✂ L 200 cm W 117 cm H 10 cm
L 78.74" W 46.06" H 3.94"
- ⚖ 21,5 kg | 47.40 lbs
- ... Black or alu cables 2 - 5 m | 78.74" - 118.11"

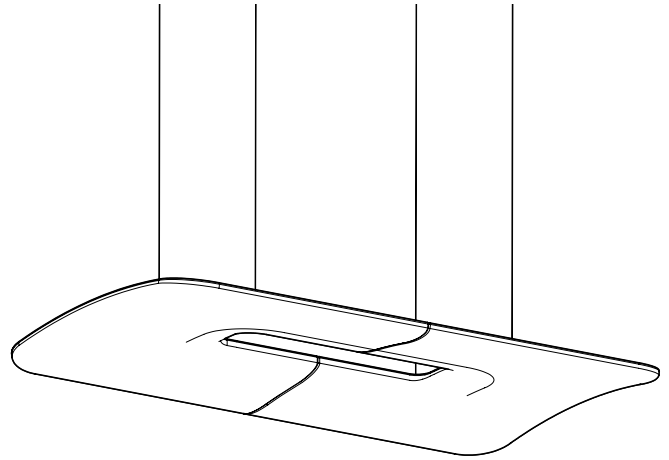

BuzziZepp Medium

- Core: Poplar multiplex
- 🌲 Filling: acoustic foam
- Cover: upholstered in fabric
- ✂ L 300 cm W 117 cm H 10 cm
L 118.11" W 46.06" H 3.94"
- ⚖ 31,4 kg | 69.23 lbs
- ... Black or alu cables 2 - 5 m | 78.74" - 118.11"

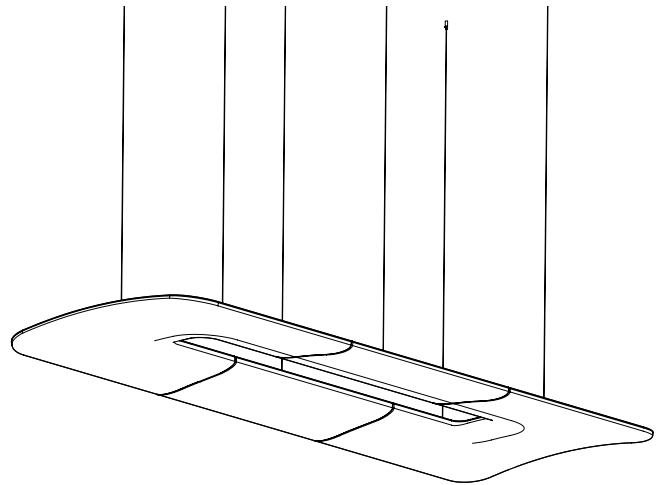

Fixing Systems

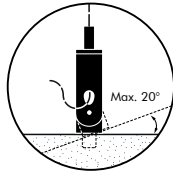
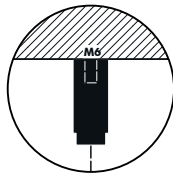
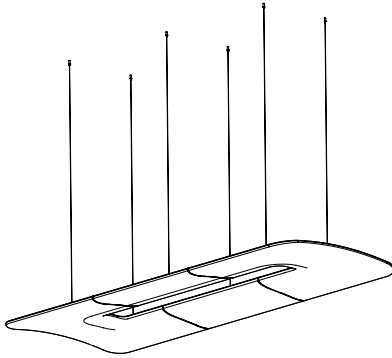

Fixing System Screw

Small: 4 cables of 2 - 5 m | 78.74" - 196.85"
black or alu cables

Medium: 6 cables of 2 - 5 m | 78.74" - 196.85"
black or alu cables

Formations, as with other architectural features located in the ceiling plane, may obstruct or skew the existing or planned fire sprinkler water distribution pattern, or possibly delay the activation of the fire sprinkler or fire detection system. Designers and installers are advised to consult a protection engineer, NFPA 13, and their local codes for guidance on the proper installation techniques where detection or suppression systems are present.

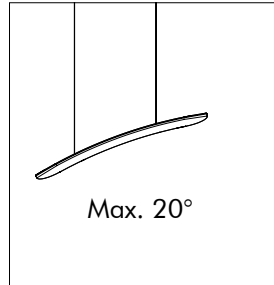
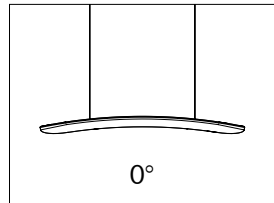

The acoustic panel can be mounted straight or slanted, with a maximum angle of 20° to create a more secluded setting.

Fabrics

Fabric (45 colors)

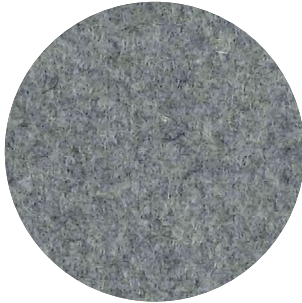

Category A

Composition 70% Recycled Wool, 25% Recycled Polyacryl,
5% Recycled Other Fabrics

Weight 405 g/m² | 11.94 oz/yd²

Abrasion resistance 40.000 Martindale, 50,000 Wyzenbeek

Flammability EU: EN 1021.1/2006 | BS EN 1021.1/2006 (cigarette).
EN 1021.2/2006 | BS EN 1021.2/2006 (match)
USA: CAL TB 117 | ASTM E84 CLASS A

Fastness to light EU: 4 | USA 4

Fastness to rubbing EU: Wet 3-4 | Dry 4-5

Fastness to crocking USA: Wet 5 | Dry 5



Trevira CS+ | CS (45 colors)

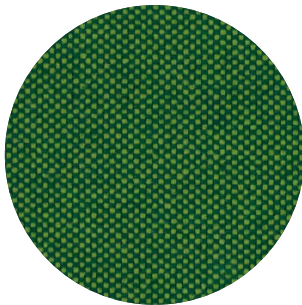

Category A

Weight 420 g/m² | 12.39 oz/yd²

Composition 100% Polyester, Trevira CS

Abrasion resistance 100.000 Martindale, 90,000 Wyzenbeek

Flammability BS 5852 part II: CRIB 5 | BS 7176 Medium Hazard
USA: CAL TB 117 | M1 | B1 | EN 1021/1-2 | C1 |
IMO Res. A652 (16)

Fastness to light EU: 6 | USA 5

Fastness to rubbing EU: Wet 4-5 | Dry 4-5

Fastness to crocking USA: Wet 5 | Dry 5



Revive 1 (25 colors)

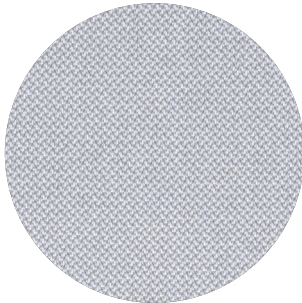

Category A

Composition 100% recycled polyester FR

Weight 430 g/lin.m

Abrasion resistance 60.000 Martindale rubs, EN ISO 12947

Flammability EN 1021-1/2 | DIN 4102 B1 | Önorm B1/Q1
UNI 9175 1IM | US Cal. Tech. Bull. 117
IMO A.652 (16)

Fastness to light Note 5-7, ISO 105-B02

Fastness to rubbing (ISO) dry 5, wet 4-5

Pilling Note 4-5, EN ISO 12945



kvadrat

Velvet (12 colors)

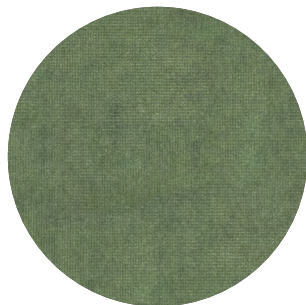

Category B
Composition 100% PES
Weight 375 g/m² | 11.06 oz/yd²
Abrasion resistance > 100.000 Martindale
Fastness to light EU: 4-5
Fastness to rubbing EU: Wet 4 | Dry 4-5
Pilling EU: 4-5

Clara 2 (24 colors)

kvadrat

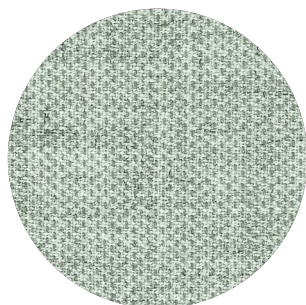

Category B
Composition 92% new wool, 8% nylon
Weight 400 g/lin.m
Abrasion resistance 80.000 Martindale rubs, EN ISO 12947
Flammability EN 1021-1/2 | BS 5852, ignition source 2-3 | DIN 4102 B2
NF D 60 013 | UNI 9175 11M | US Cal. Tech. Bull. 117, Sec. E
NFPA 260 | IMO A.652(16)
Fastness to light Note 5-7, ISO 105-B02
Fastness to rubbing (ISO) dry 4-5, wet 4
Pilling Note 4, EN ISO 12945



Remix 3 (73 colors)

kvadrat



Category B
Composition 90% new wool, 10% nylon
Weight 415 g/lin.m
Abrasion resistance 100.000 Martindale rubs, EN ISO 12947
Flammability EN 1021-1/2 | BS 5852 part 1
Önorm B1/Q1 | NF D 60 013 | UNI 9175, 11M
AS/NZS 1530.3 | Cal. Tech. Bull. 117-2013
NFPA 260 | IMO FTP Code 2010:Part 8
Fastness to light Note 5-7, ISO 105-B02
Fastness to rubbing (ISO) dry 4-5, wet 4
Pilling Note 4, EN ISO 12945



Hero 2 (33 colors)

kvadrat

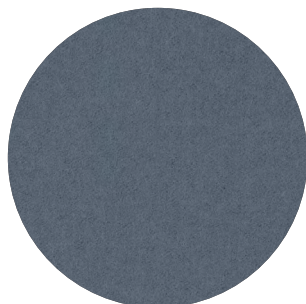

Category C
Composition 97% new wool, 3% nylon
Weight 580 g/lin.m
Abrasion resistance 45.000 Martindale rubs, EN ISO 12947
Flammability EN 1021-1/2 | DIN 4102 B2 | NF D 60 013
UNI 9175 11M | US Cal. Bull. 117-2013 | NFPA 260
IMO A.652 (16)
Fastness to light Note 5-6, ISO 105-B02
Fastness to rubbing (ISO) dry 4-5, wet 4-5
Pilling Note 3-4, EN ISO 12945



Tonus 4 (47 colors)

kvadrat



Category D

Composition 90% new wool, 10% Helanca

Weight 665 g/lin.m

Abrasion resistance 100.000 Martindale rubs, EN ISO 12947

Flammability EN 1021-1/2 | BS 5852 part 1 | DIN 4102 B2

Önorm B1/Q1 | NF D 60 013 | UNI 9175 11M

US Cal. Bull. 117-2013 | NFPA 260 | IMO A.652 (16)

Fastness to light Note 5-7, ISO 105-B02

Fastness to rubbing (ISO) dry 3-5, wet 3-5

Pilling Note 3, EN ISO 12945



Memory 2 (20 colors)

kvadrat

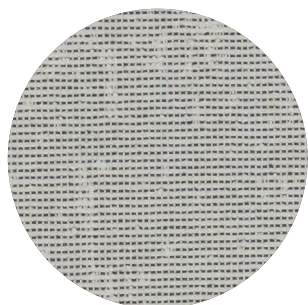

Category E

Composition 100% Trevira CS

Weight 700 g/lin.m

Abrasion resistance

35.000 rubs acc. to the Martindale method, EN ISO 12947

Flammability EN 1021-1/2 | DIN 4102 B1 | Önorm B1/Q1

NF D 60 013 | NF P 92 507 M1 | UNI 9175 11M

UNI 9177 classe 1 | US Cal. Tech. Bull. 117

IMO A.652 (16)

Fastness to light Note 5-8, ISO 105-B02

Fastness to rubbing (ISO) dry 4-5, wet 4-5

Pilling Note 4, EN ISO 12945



Dimensions

Small

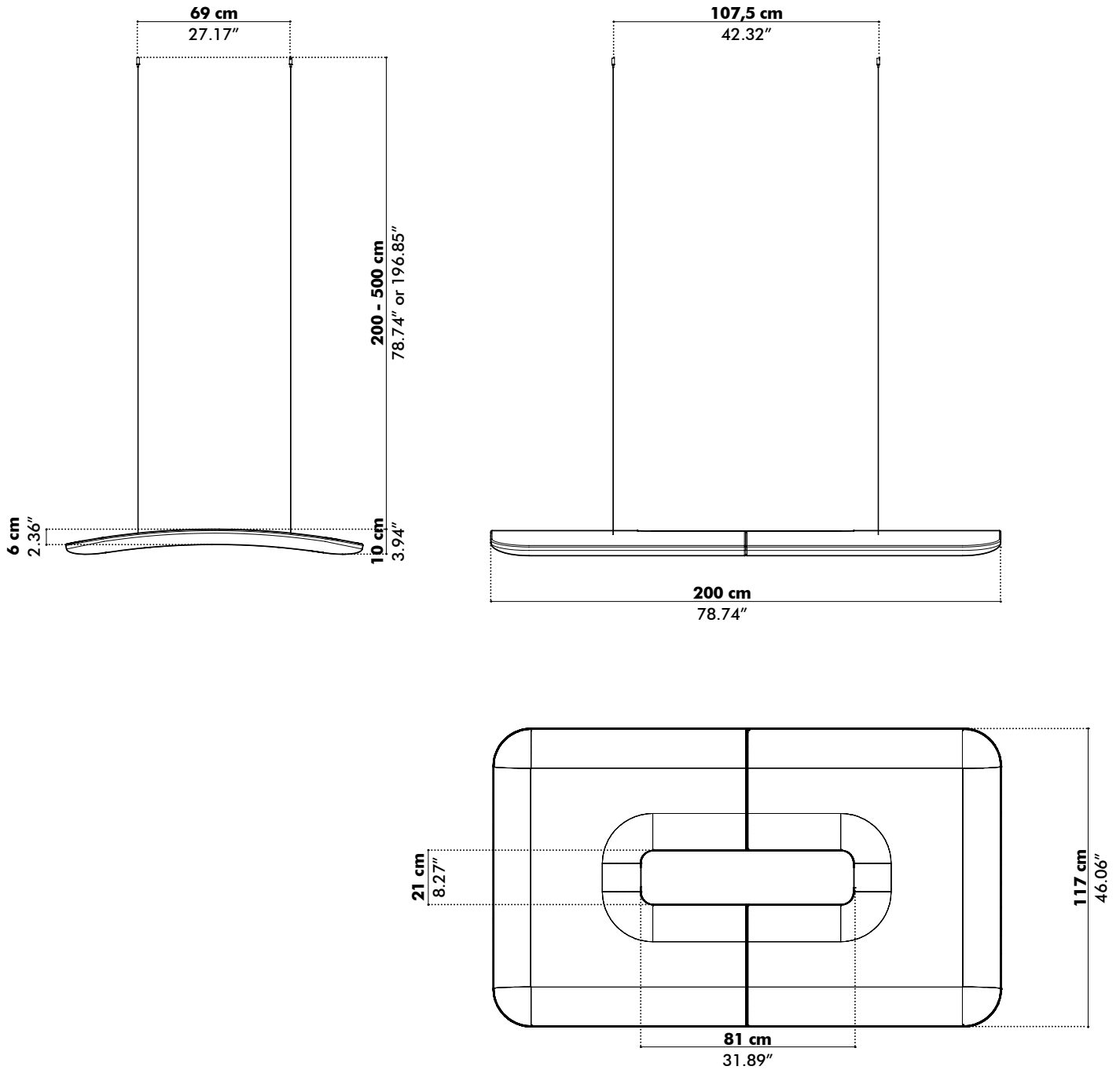

Medium

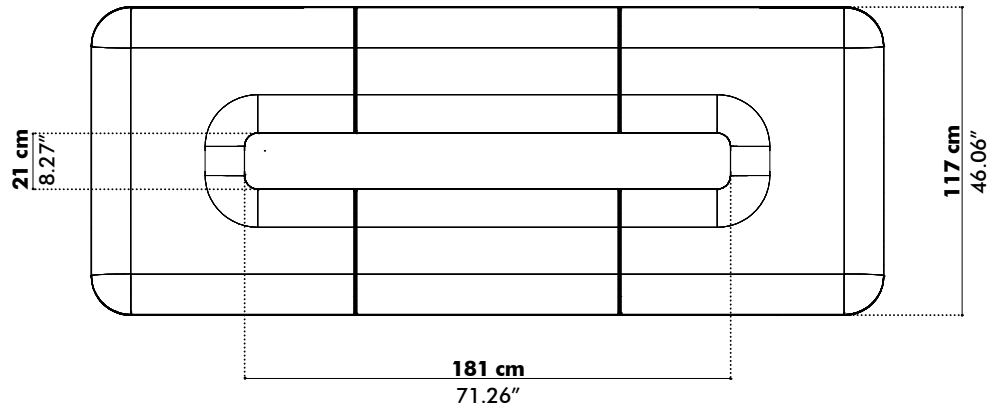
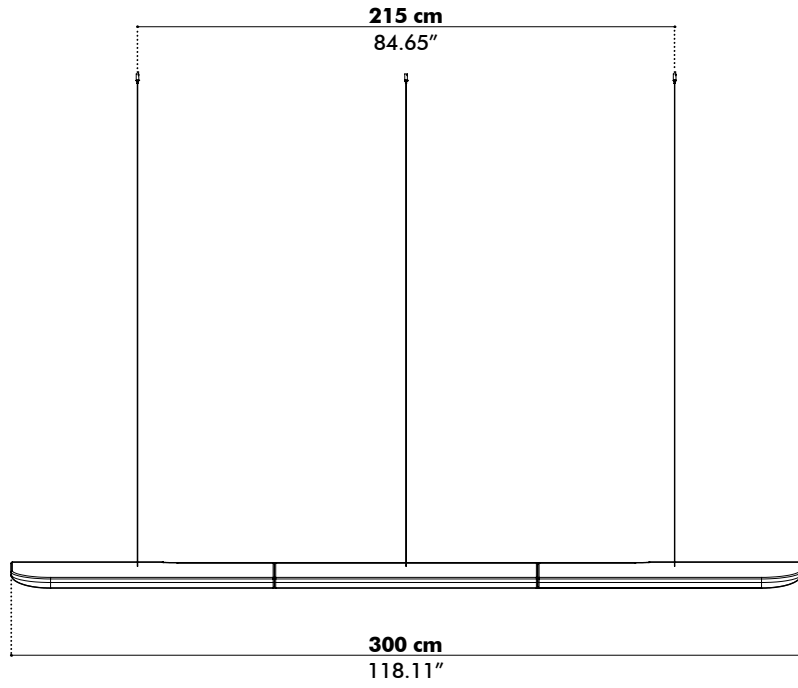
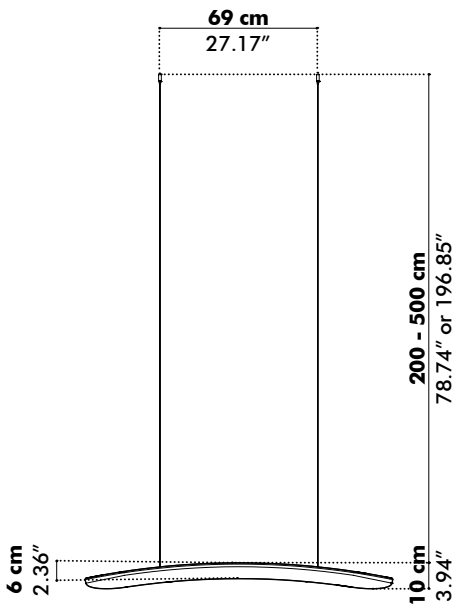

Acoustics

BuzziZepp

Absorption coefficient

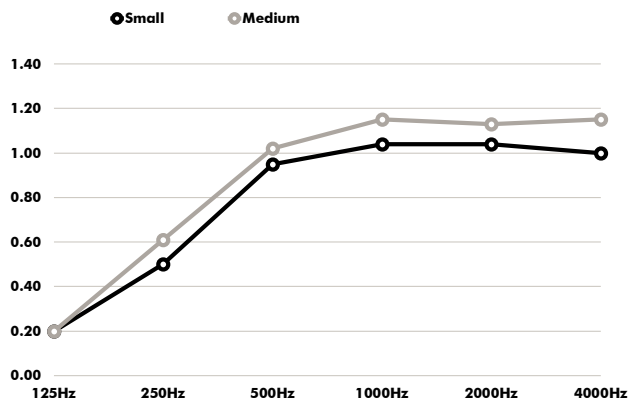

Hz	α ^s Small	α ^s Medium
125	0.20	0.20
250	0.50	0.61
500	0.95	1.02
1000	1.04	1.15
2000	1.04	1.13
4000	1.00	1.15

Absorption Values Small

α^w
(ISO 11654) **0.80**

NRC
(ASTM - C423) **0.90**

SAA
(ASTM - C423) **0.88**

Class
(ISO 11654) **A**

Absorption Values Medium

α^w
(ISO 11654) **0.90**

NRC
(ASTM - C423) **1.00**

SAA
(ASTM - C423) **0.98**

Class
(ISO 11654) **A**

Equivalent sound absorption area in m² per object

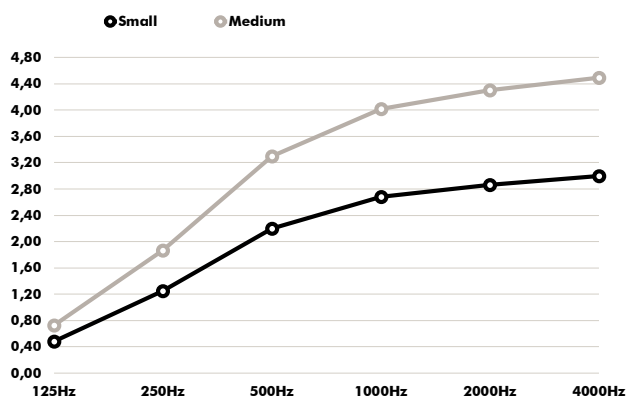

Hz	A _{eq} /m ² Small	A _{eq} /m ² Medium
125	0.48	0.73
250	1.25	1.87
500	2.20	3.30
1000	2.68	4.02
2000	2.86	4.30
4000	3.00	4.49

Glossary p.12

Glossary

All calculations are based on accredited lab measurements, official document available on www.buzzi.space

Definitions

α	Weighted absorption coefficient	(ISO 11654)
NRC	Noise reduction coefficient	(ASTM - C423)
SAA	Sound absorption average	(ASTM - C423)

Classification of sound absorbers NEN-EN-ISO 11654

A	0.90 0.95 1.0
B	0.80 0.85
C	0.60 0.65 0.70 0.75
D	0.03 0.55
E	0.15 0.25