

# WOOLLY SHEPHERD LTD

## INSTALLATION MANUAL

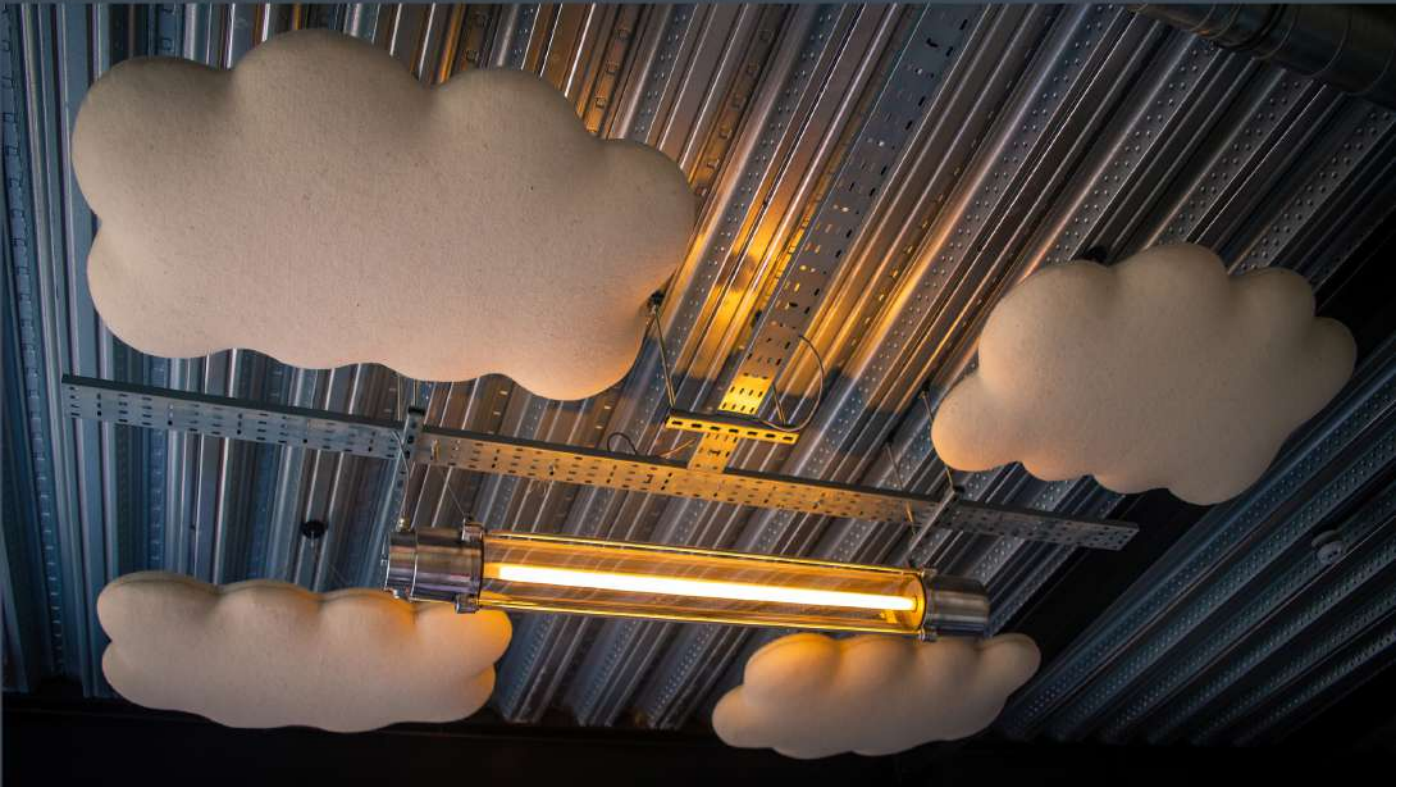

Tel: 01823 400321

Email: [info@woollyshepherd.co.uk](mailto:info@woollyshepherd.co.uk)

Leatside Foxes Yard Milverton Road Tonedale Wellington Somerset TA21 0AJ



SUSTAINABLE DESIGN  
AWARD 2019

# SUSPENDED ACOUSTIC CLOUD

All suspended panels come with a security wire.  
Fit second hook 100mm from fixing hook and attach security cable.

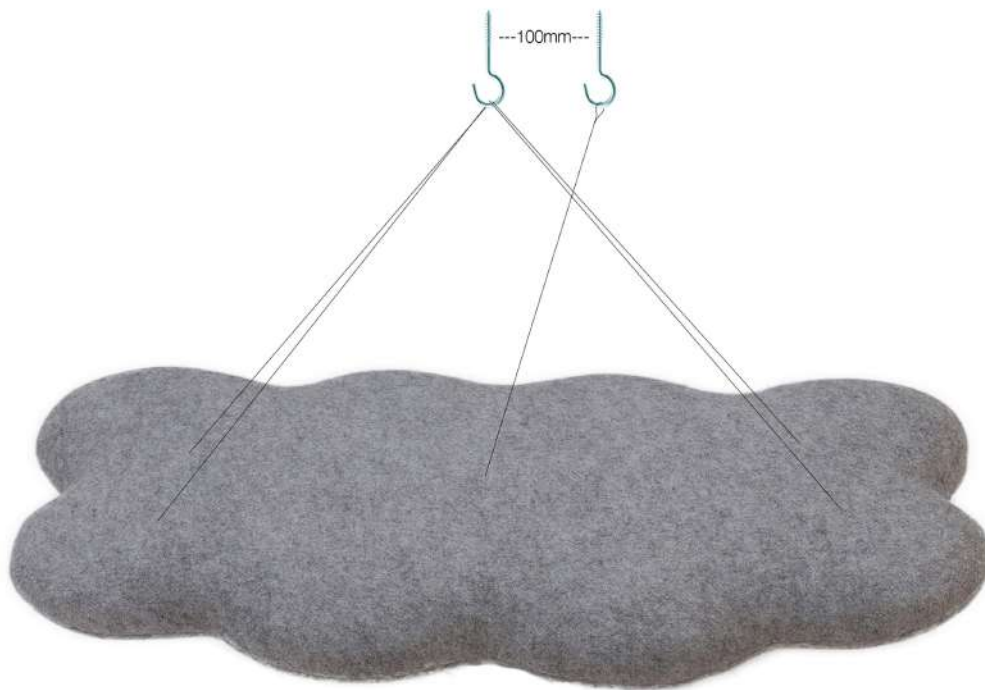

To adjust direction of panel turn hook.

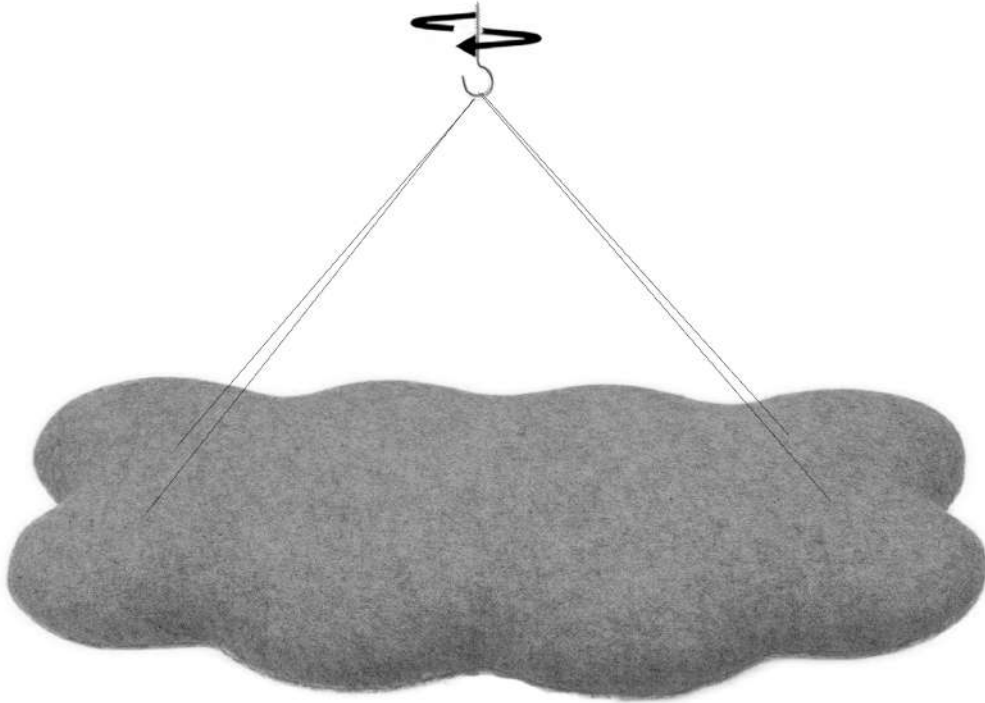

To adjust the angle of cloud gently tilt cloud to desired angle and hold until steady.



# SUSPENDED RECTANGLE FIXINGS

Suspended rectangles are fixed from four separate hooks.

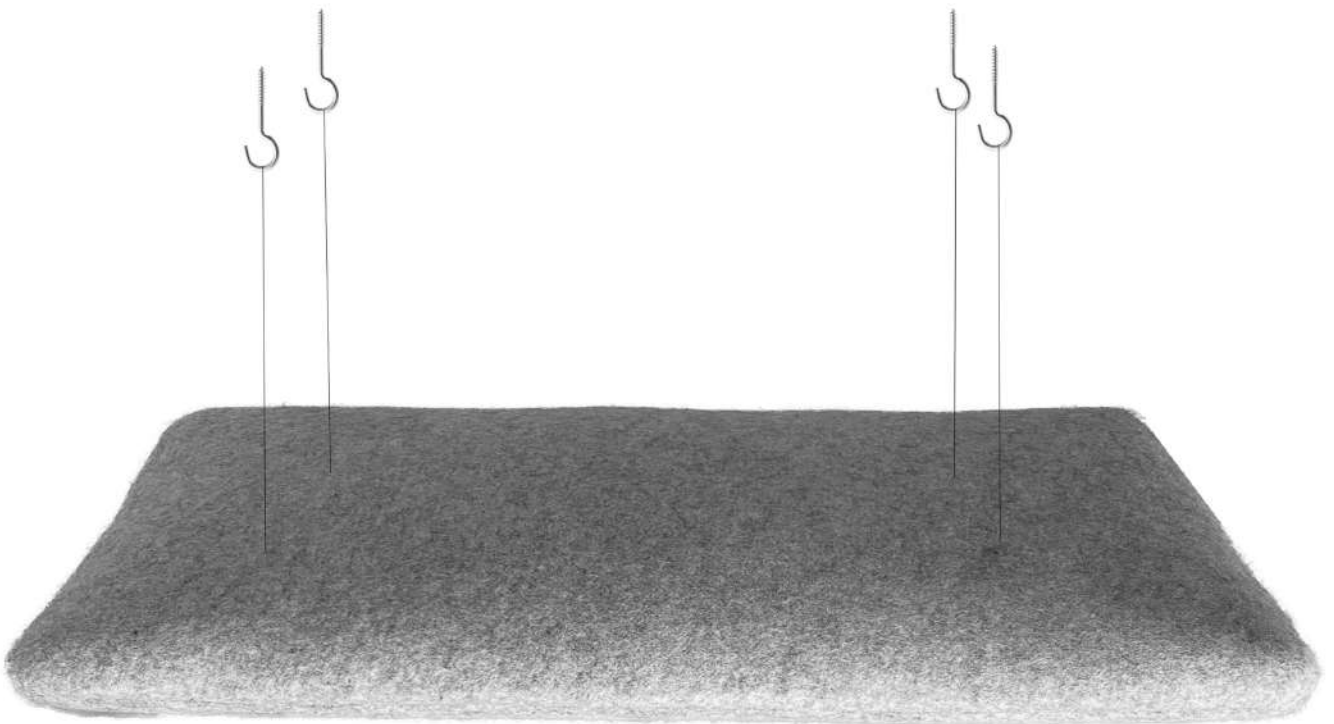

# LIMPET MAGNETIC FIXINGS

All limpet panels come supplied with a template to help position the panel and fit metal wall plates in their correct position.

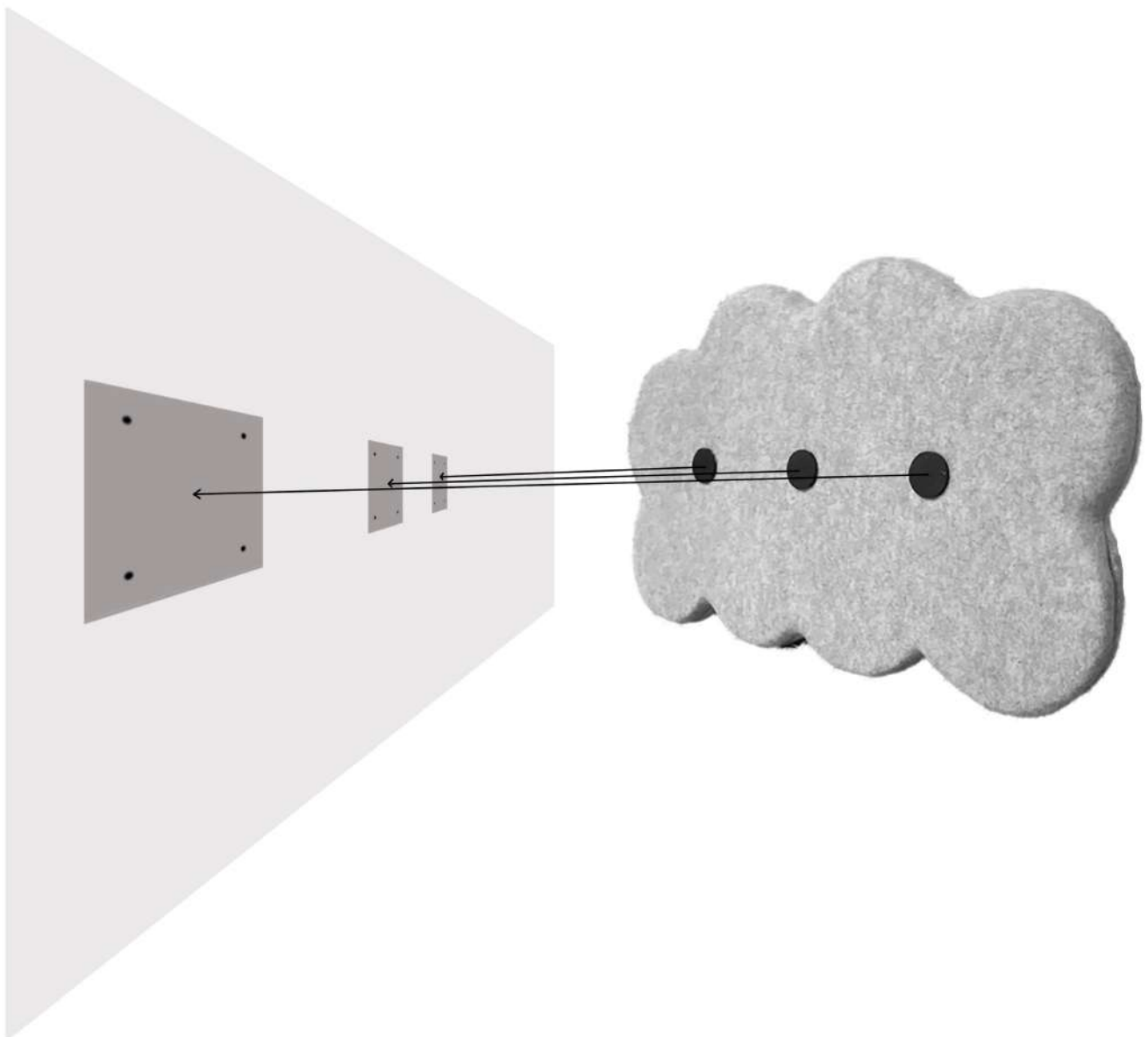

# THUNDERBOLT HOOK FIXINGS

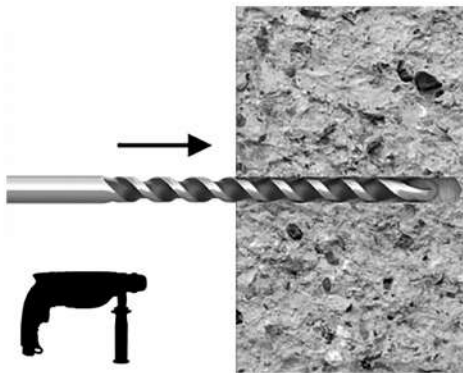

Using 6mm masonry drill hole to 50mm depth.

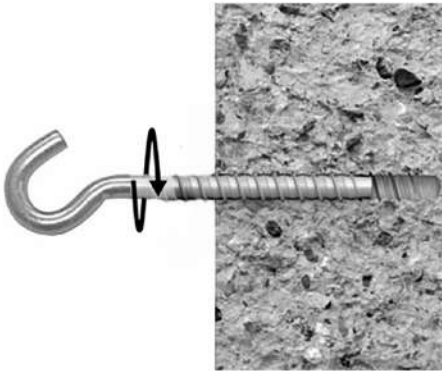

Insert Thunderbolt fixing and screw in clockwise direction.



Finished Thunderbolt fixing.

# SNAPTOGGLE FIXINGS (LATH & PLASTER)

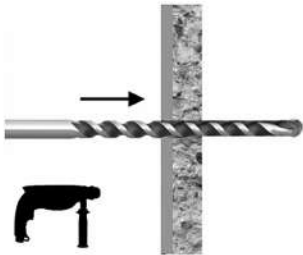

Drill through lath and plaster ceiling with 13mm masonry drill.



Hold metal channel flat alongside plastic straps & slide channel through the hole. Minimum clearance behind ceiling 50mm.

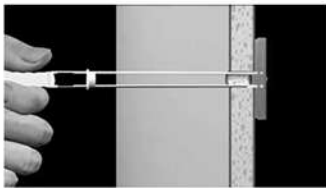

Hold ends of straps together between thumb & forefinger and pull toward you until channel rests behind ceiling.

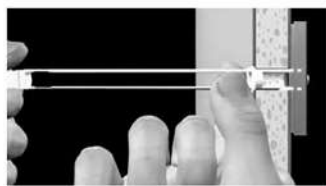

Ratchet cap along straps with other hand until flange of cap is flush with ceiling.

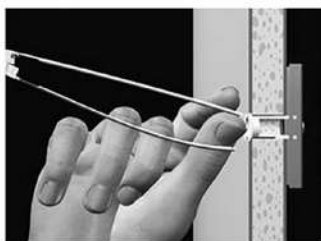

Place thumb between straps at ceiling and push thumb side to side, snapping off straps level with flange of cap.



Screw in M6 threaded hook until firmly fixed to the rear metal channel.

# PLATE FIXINGS (DRYWALL)

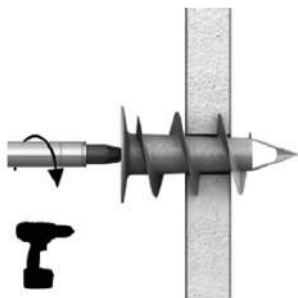

Using a PZ2 screwdriver, push fixing point firmly into the board until thread engages. Maintaining a firm pressure, screw in fixing until flush with the base material.

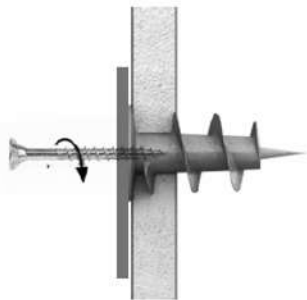

Place plate in position and insert screws, tighten until secure.



Finished drywall plate fitting.



# PLATE FIXINGS (MASONRY)

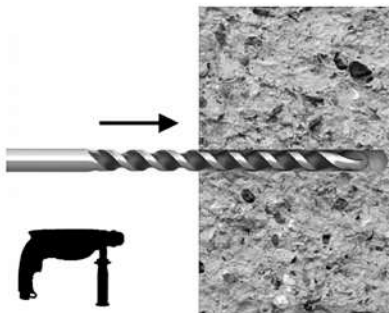

Using 6mm masonry drill make hole to 35mm depth.

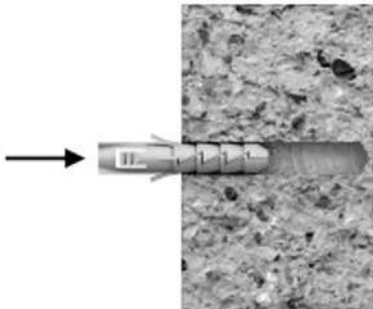

Insert plug and if needed tap lightly with hammer.



Hold plate in place and screw (M4 x 30mm) through into plugs.

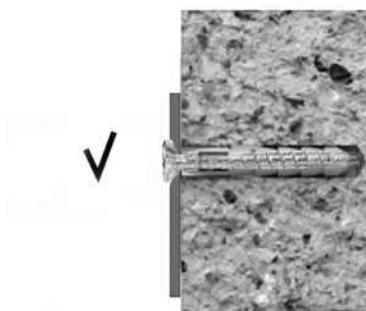

Finished fixed plate.

# METAL PLATE FIXING

Metal Plates to be fitted as specified by supplied template.

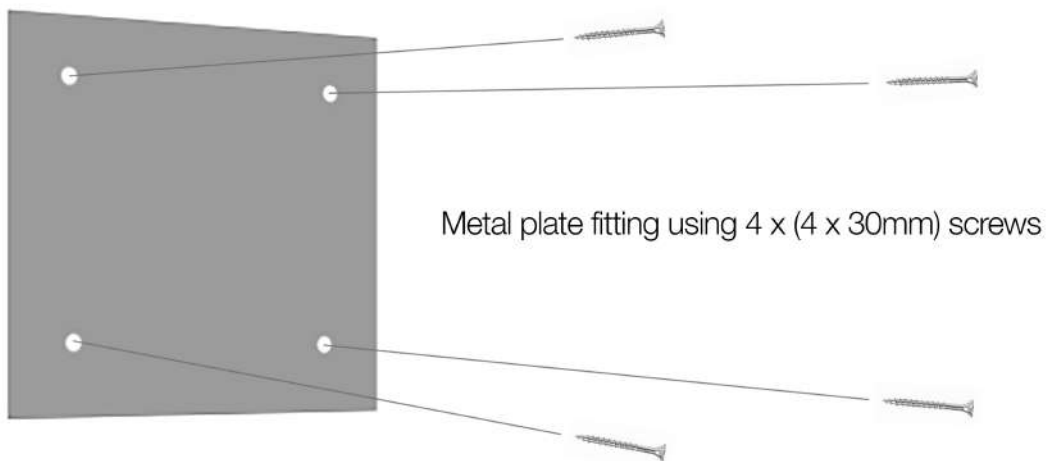

# MAGNETIC FIXINGS

As well as traditional wall fixings, we also offer a range of bespoke magnetic hooks and fittings.



# SUSPENDED CLOUD

Cable positions.

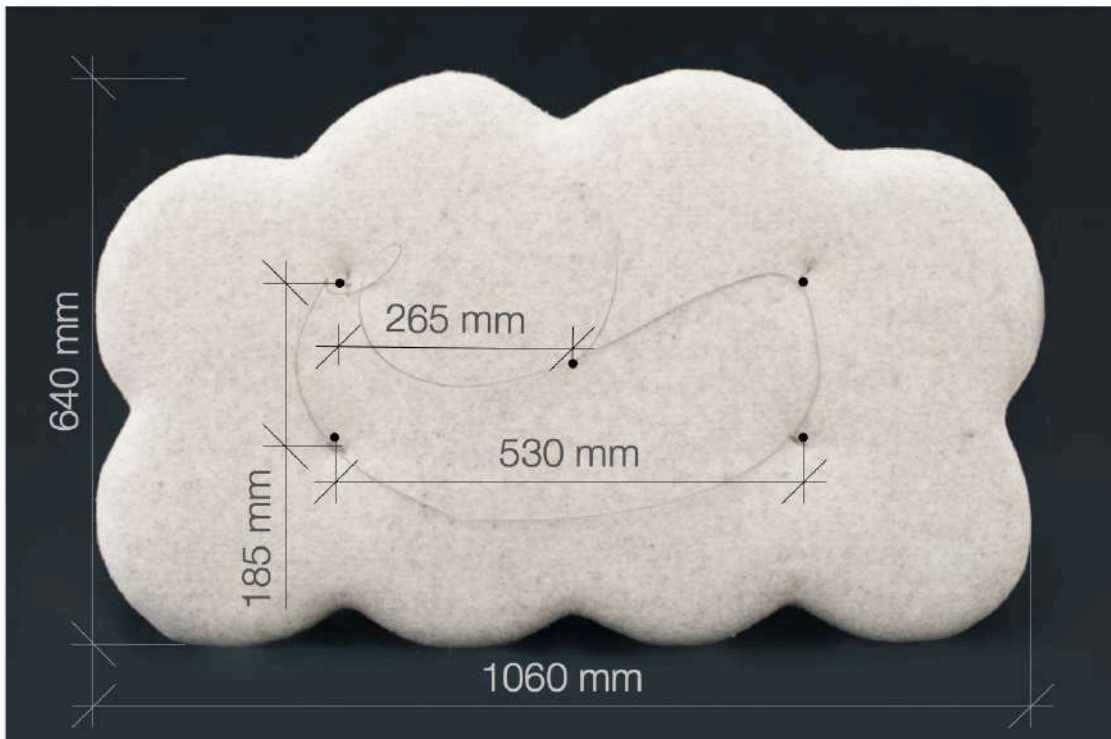

# LIMPET CLOUD

## Sizes and plate position

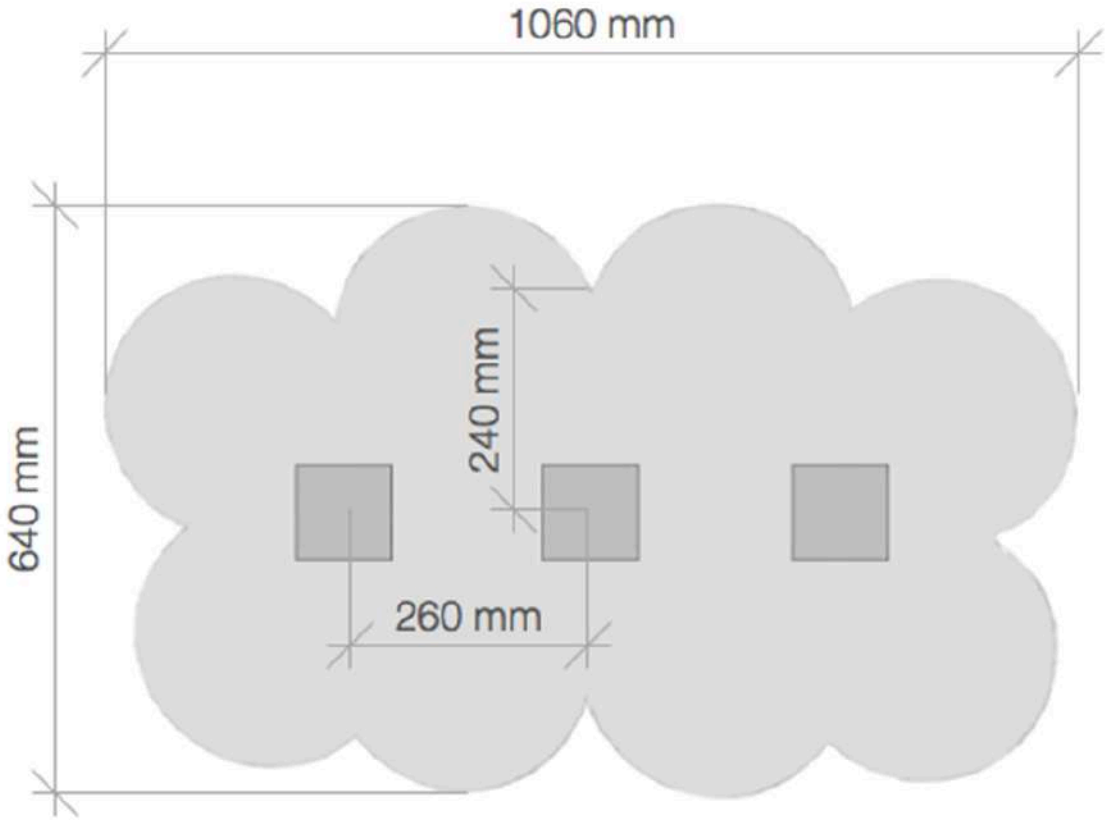

# LIMPET RECTANGLE

## Sizes and plate position

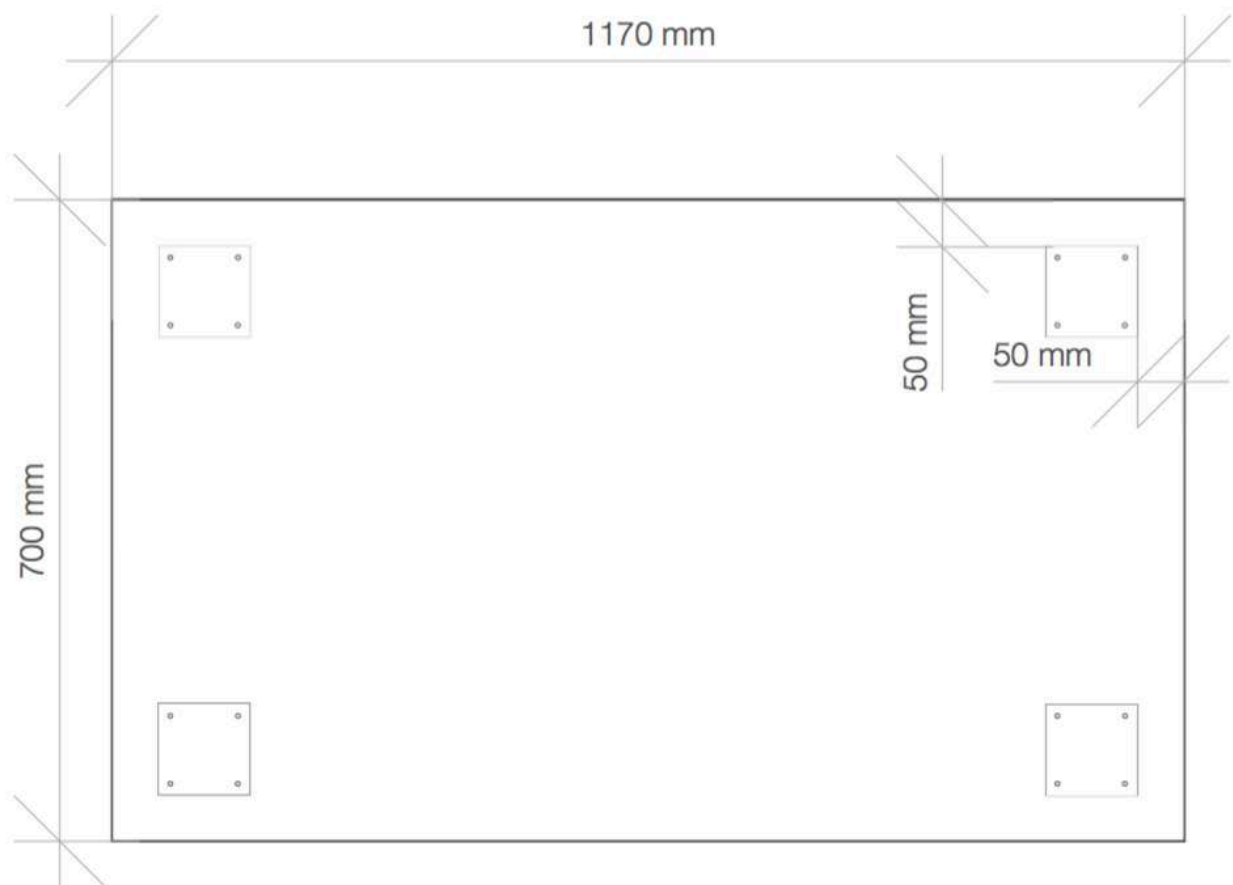

# STONE CLUSTER (LARGE)

## Sizes and plate position

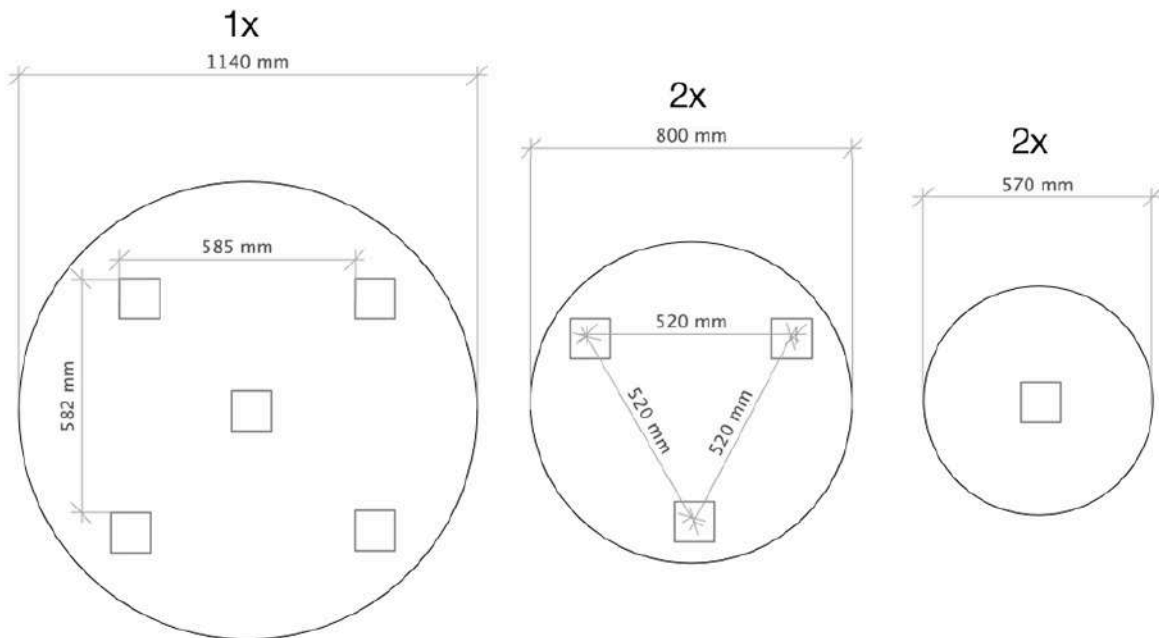

# STONE CLUSTER (SMALL)

## Sizes and plate positions

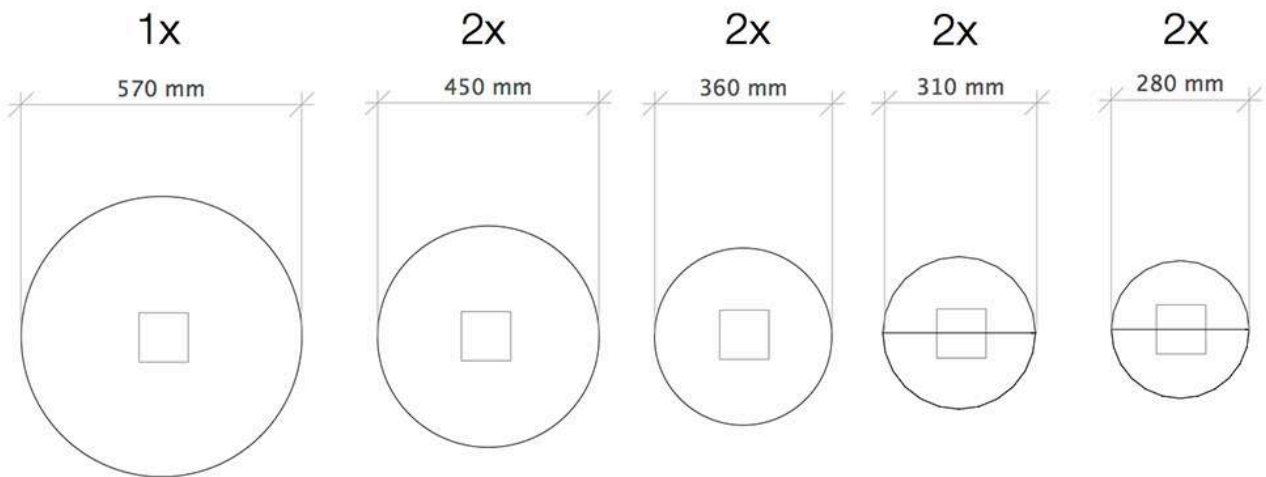



# COLOURS

