

Ecophon Focus™ E

Ecophon Focus™ E has a recessed visible grid and a tegular edge, creating a ceiling with a shadow effect that accentuates each tile and partially conceals the grid. For applications where an attractive suspended ceiling is required and easy removal of individual tiles is essential.



Wihlborgs Fastigheter, Helsingborg, Sweden

SYSTEM RANGE

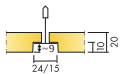

Size, mm	600x600	625x625	1200x600	1200x1200	XL 1600x600	XL 1800x600	XL 2000x600	XL 2400x600
Connect T15	•		•	•				
Connect T24	•	•	•	•	•	•	•	•
Thickness (THK)	20	20	20	20	20	20	20	20
Inst. Diagr.	M12	M12 DIN	M12	M12	M47, M49	M47, M49	M47, M49	M47, M49

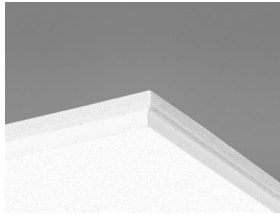

Focus E tile

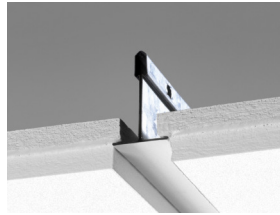

Section of Focus E system with Connect T24

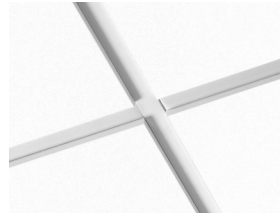

Focus E system

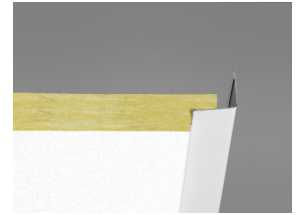

Focus E with Connect Angle trim

Acoustic



Sound Absorption:

Test results according to EN ISO 354. Classification according to EN ISO 11654, and the single value ratings for Noise Reduction Coefficient, NRC and Sound Absorption Average, SAA according to ASTM C 423.

α_p , Practical sound absorption coefficient

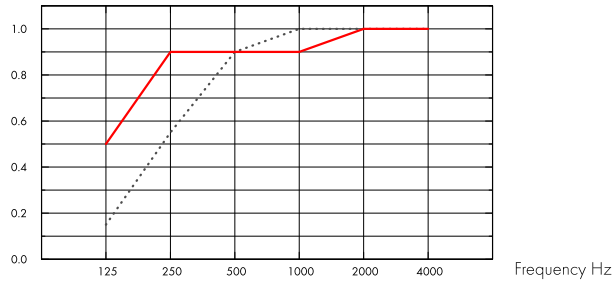

..... Focus E 20 mm, 60 mm o.d.s.

— Focus E 20 mm, 200 mm o.d.s.

o.d.s = overall depth of system

THK mm	o.d.s. mm	α_p , Practical sound absorption coefficient						α_w	Sound absorption class
		125 Hz	250 Hz	500 Hz	1000 Hz	2000 Hz	4000 Hz		
20	60	0.15	0.55	0.90	1.00	1.00	1.00	0.85	B
20	200	0.50	0.90	0.90	0.90	1.00	1.00	0.95	A

THK mm	o.d.s. mm	NRC	SAA
20	60	0.90	0.87
20	400	0.85	0.85

THK mm	AC(1.5)	D_{nfw}	CAC dB
	Articulation Class, ASTM E1111, ASTM E1110	Weighted normalized flanking level difference, ISO 10848-2	Ceiling Attenuation Class, ASTM 1414, ASTM E413
20	180	22	23

Indoor Air Quality



Certificate / Label	Plant	
Eurofins Indoor Air Comfort®	IAC	IAC Gold
French VOC	A	A+
Finnish M1	•	•



Environmental Footprint



	kg CO ₂ equiv/m ²
Focus E	3,66
Focus E/Plant	2,35

Life-cycle stages A1 to C4 from EPD, in conformity with ISO 14025 / EN 15804



Circularity

Minimum post-consumer recycled content	55%
Recyclability	Fully recyclable



Fire safety

Country	Class	
Europe	EN 13501-1	A2-s1,d0

The glass wool core of the tiles is tested and classified as non-combustible according to EN ISO 1182.



Humidity Resistance

Product	
Standard	Class C, RH 95% and 30°C
Plant	Class A, RH 70% and 25°C

According to EN 13964:2014



Visual appearance

White Frost, nearest NCS colour sample S 0500-N, 85% light reflectance. Gloss < 1.



Cleanability

Daily dusting and vacuum cleaning. Weekly wet wiping.



Accessibility

The tiles are easily demountable. Minimum demounting depth according to installation diagrams.



Installation

Installed according to installation diagrams, installation guides and drawing aid. For information regarding minimum overall depth of system see quantity specification.



System weight

The weight of the system (including suspension grid) should be approximately 3 kg/m².



Mechanical properties

See table about Max live load and Min load bearing capacity and Functional demands, Mechanical properties at www.ecophon.com.



CE

Ecophon ceiling systems are CE marked according to the European harmonized standard EN 13964:2014. CE marked construction products are covered by a Declaration of Performance (DOP) which enables customers and users to easily compare performance of products available on the European market.

INSTALLATION DIAGRAM (M12) FOR ECOPHON FOCUS E

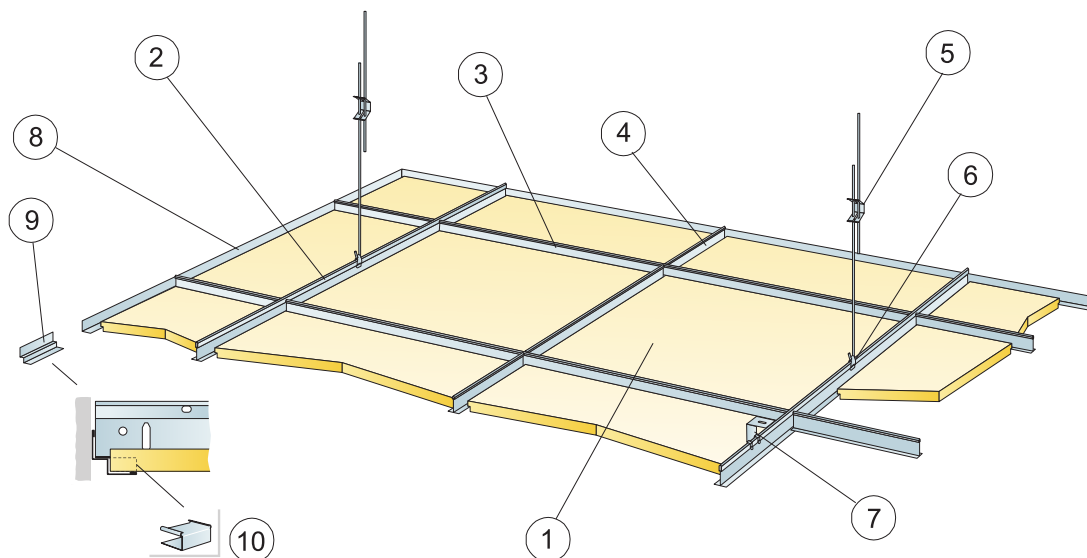

© Ecophon Group

QUANTITY SPECIFICATION [EXCL. WASTAGE]

	Size, mm		
	600x600	1200x600	1200x1200
1 Focus E T24 or T15	2,8/m ²	1,4/m ²	0,7/m ²
2 Connect T24 or T15 Main runner, installed at 1200 mm centres (max. distance from wall 600 mm, can be extended up to 1200 mm if no live load between Main runner and wall).	0,9m/m ²	0,9m/m ²	0,9m/m ²
3 Connect T24 or T15 Cross tee, L=1200 mm	1,7m/m ²	1,7m/m ²	0,9m/m ²
4 Connect T24 or T15 Cross tee, L=600 mm	0,9m/m ²	-	-
5 Connect Adjustable Hanger, installed at 1200 mm centres (max. distance from wall 600 mm)	0,7/m ²	0,7/m ²	0,7/m ²
6 Connect Hanger Clip (not to be used in swimming hall environments)	0,7/m ²	0,7/m ²	0,7/m ²
7 For direct installation: Connect Direct Bracket, installed at 1200 mm centres	0,7/m ²	0,7/m ²	0,7/m ²
8 Connect Angle trim, fixed at 300 mm centres	as required	as required	as required
9 Connect Shadow-line trim, fixed at 300 mm centres	as required	as required	as required
10 Connect E-plug (for Shadow-line trim)	as required	as required	as required
Δ Min. overall depth of system, with adjustable hanger: 110 mm, with direct bracket: 60 mm	-	-	-
δ Min. demounting depth: 120 mm, (1200x1200 mm, T15: 160 mm)	-	-	-
For luminaire integration in panels use Connect Bridging	-	-	-

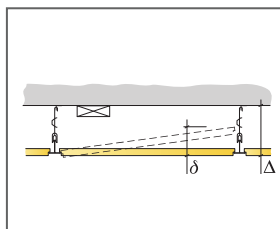

See Quantity specification

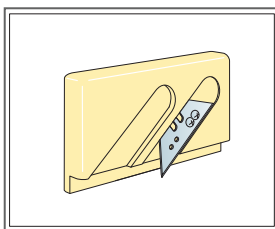

Cutting tool E

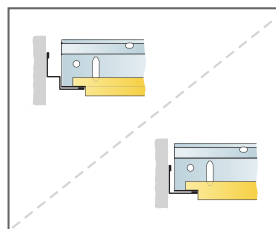

Tegular rebate with angle trim and T-profile on foot of shadow-line trim.

Size, mm	Max live load (N)	Min load bearing capacity (N)
600x600x20	50	160
1200x600x20	50	160
1200x1200x20	50	160

Live load/load bearing capacity

INSTALLATION DIAGRAM (M12) FOR ECOPHON FOCUS E

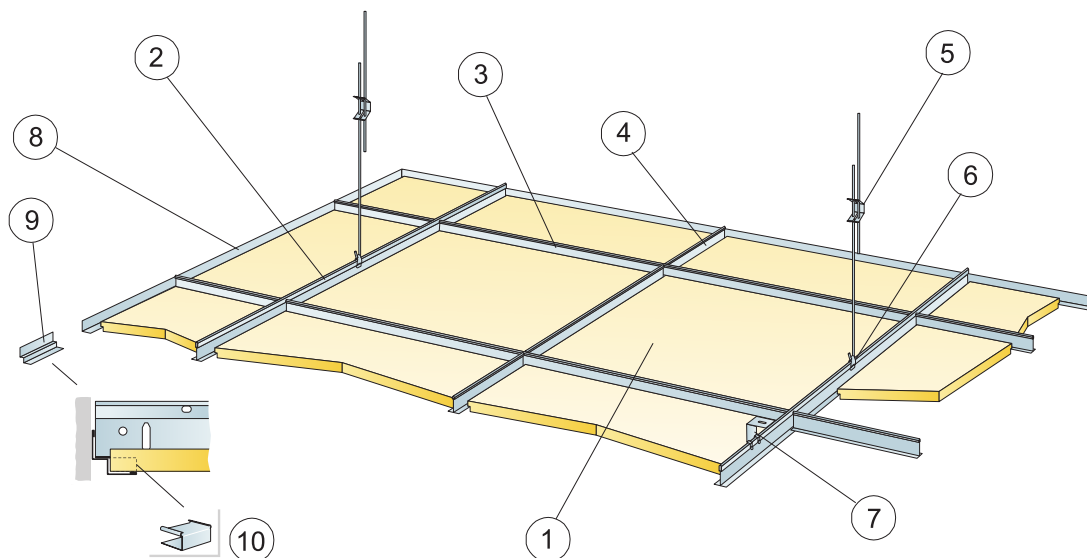

© Ecophon Group

QUANTITY SPECIFICATION (EXCL. WASTAGE)

	Size, mm
	625x625
1 Focus E T24 or T15	2,6/m ²
2 Connect T24 Main Runner, installed at 1250 mm centres for DIN [only white profiles]	0,8m/m ²
3 Connect T24 or T15 Cross Tee, L=1250 mm, installed at 625 mm centres	1,6m/m ²
4 Connect T24 or T15 Cross Tee, L=625 mm	0,8m/m ²
5 Connect Adjustable Hanger, installed at 1250 mm centres [max. distance from wall 600 mm]	0,7/m ²
6 Connect Hanger Clip (not to be used in swimming hall environments)	0,7/m ²
7 For direct installation: Connect Direct Bracket, installed at 1250 mm centres	0,7/m ²
8 Connect Angle trim, fixed at 300 mm centres	as required
9 Connect Shadow-line trim, fixed at 300 mm centres	as required
10 Connect E-plug (for Shadow-line trim)	as required
Δ Min. overall depth of system, with adjustable hanger: 110 mm, with direct bracket: 60 mm	-
δ Min. demounting depth: 120 mm	-
For luminaire integration in panels use Connect Bridging	-

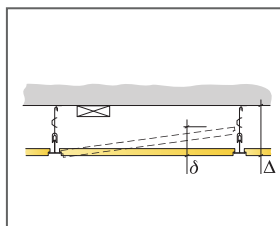

See Quantity specification

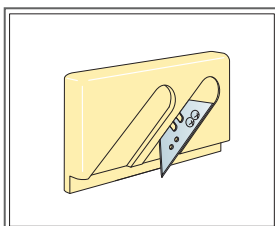

Cutting tool E

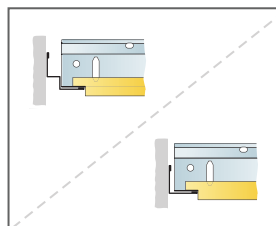

Regular rebate with angle trim and T-profile on foot of shadow-line trim.

Size, mm	Max live load (N)	Min load bearing capacity (N)
625x625x20	35	160

Live load/load bearing capacity

INSTALLATION DIAGRAM (M47) FOR ECOPHON FOCUS E XL

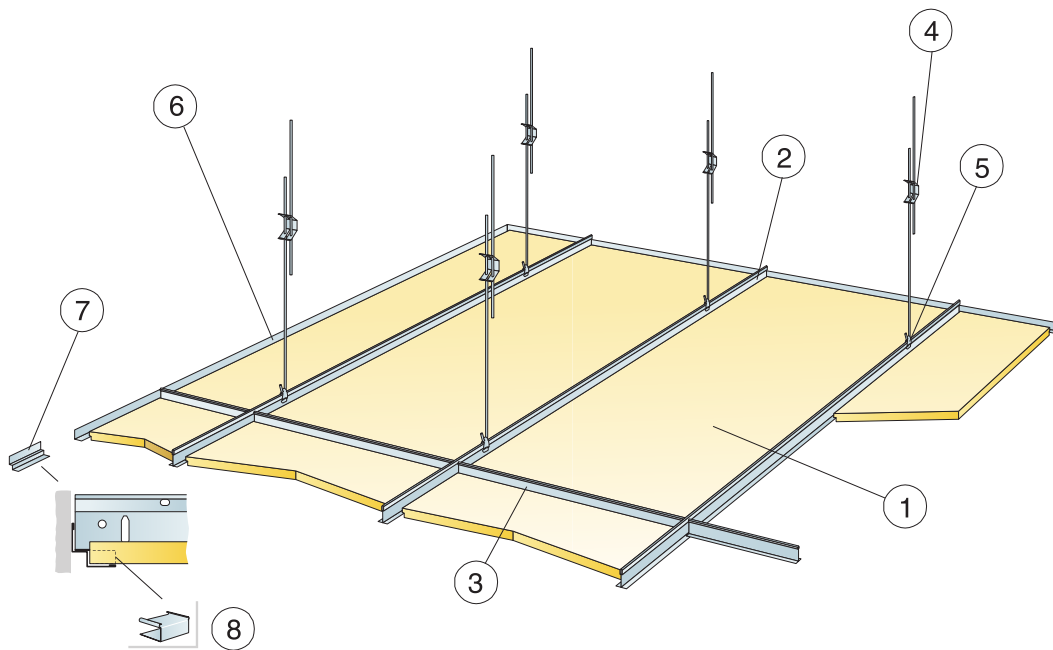

© Ecophon Group

QUANTITY SPECIFICATION (EXCL. WASTAGE)

	Size, mm			
	1600x600	1800x600	2000x600	2400x600
1 Focus E	1,05/m ²	0,95/m ²	0,85/m ²	0,7/m ²
2 Connect T24 Main runner, installed at 600 mm centres	1,7m/m ²	1,7m/m ²	1,7m/m ²	1,7m/m ²
3 Connect T24 Cross tee, L=600 mm	0,65m/m ²	0,6m/m ²	0,5m/m ²	0,45m/m ²
4 Connect Adjustable hanger, installed at 1500 mm centres (max. distance from wall 450 mm)	1,1/m ²	1,1/m ²	1,1/m ²	1,1/m ²
5 Connect Hanger clip	1,1/m ²	1,1/m ²	1,1/m ²	1,1/m ²
6 Connect Angle trim, fixed at 300 mm centres	as required	as required	as required	as required
7 Connect Shadow-line trim, fixed at 300 mm centres	as required	as required	as required	as required
8 Connect E-plug (for Shadow-line trim)	as required	as required	as required	as required
Δ Min. overall depth of system: 110 mm	-	-	-	-
δ Minimum demounting depth: 110 mm	-	-	-	-

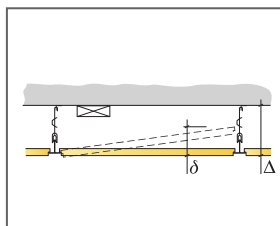

See Quantity specification

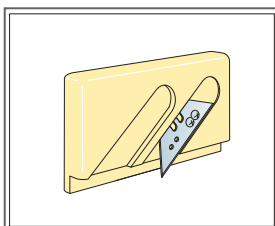

Cutting tool E

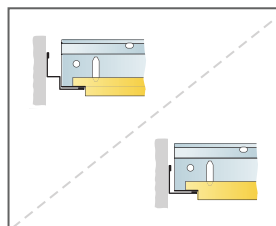

Regular rebate with angle trim and T-profile on foot of shadow-line trim.

Size, mm	Max live load (N)	Min load bearing capacity (N)
1600x600x20	50	160
1800x600x20	50	160
2000x600x20	50	160
2400x600x20	50	160

Live load/load bearing capacity

INSTALLATION DIAGRAM (M49) FOR ECOPHON FOCUS E XL IN CORRIDORS

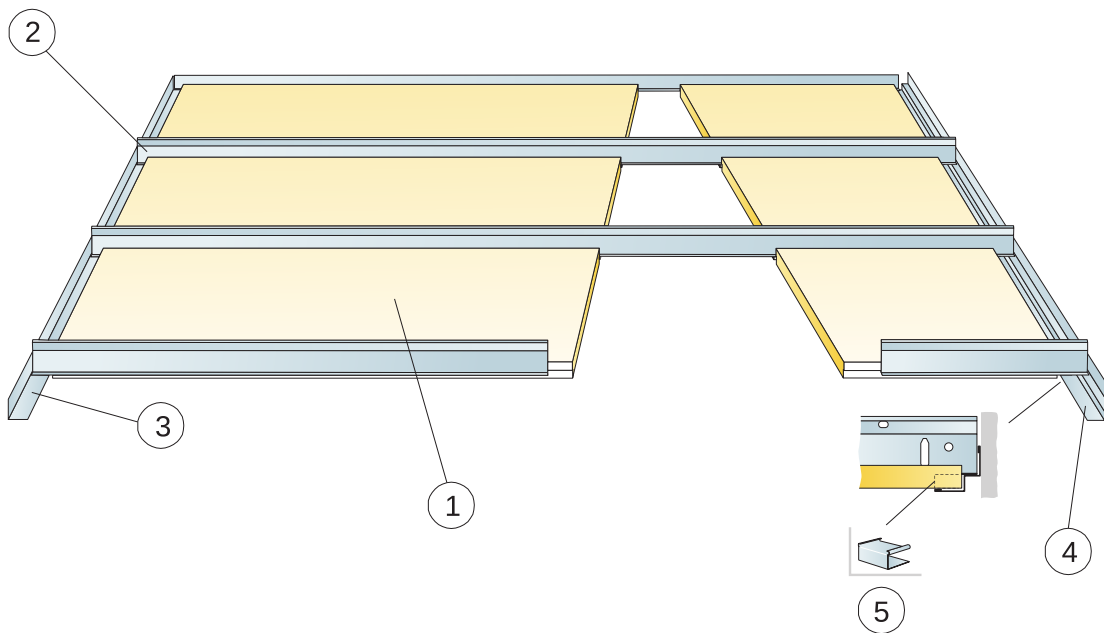

© Ecophon Group

QUANTITY SPECIFICATION (EXCL. WASTAGE)

	Size, mm			
	1600x600	1800x600	2000x600	2400x600
1 Focus E	1,05/m ²	0,95/m ²	0,85/m ²	0,7/m ²
2 Connect T24 Corridor profile, installed at 600 mm centres	1,05/m ²	0,95/m ²	0,85/m ²	0,7/m ²
3 Connect Angle trim, fixed at 200 mm centres	as required	as required	as required	as required
4 Connect Shadow-line trim, fixed at 200 mm centres	as required	as required	as required	as required
5 Connect Eplug (for Shadow-line trim)	as required	as required	as required	as required
Δ Min. overall depth of system: 50 mm	-	-	-	-
δ Min. demounting depth: 75 mm	-	-	-	-

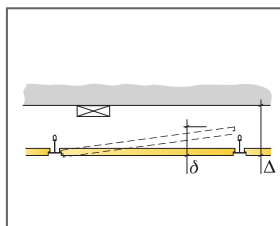

See Quantity specification

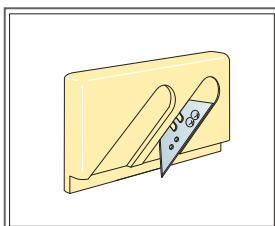

Cutting tool E

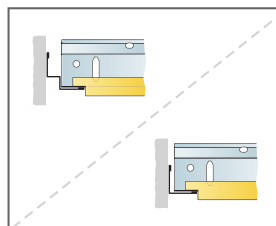

Regular rebate with angle trim and T-profile on foot of shadow-line trim.

Size, mm	Max live load (N)	Min load bearing capacity (N)
1600x600x20	40	-
1800x600x20	20	-
2000x600x20	10	-
2400x600x20	0	-

Live load/load bearing capacity