



Product Specification Sheet

BuzziHat 120-277V

— By Alain Gilles

Say goodbye to noisy environments with BuzziHat

A decorative and highly recognizable hat-shaped pendant light with excellent sound absorption capabilities.

Its unique design, combining an upholstered part with a metal shade is bound to steal the attention in any space.

The upholstered foam body is available in a wide palette of color and fabric combinations, while the metal shade and ring come in 4 finishes (black, white, beige red and gold). Mix colors of your choosing and match the fabric of BuzziHat with the color of your furniture to create an impeccable setting. BuzziHat is available in different sizes to fit different sonic environments which makes it the ultimate acoustic lighting for any office, lobby or restaurant that needs acoustic absorption treatment combined with high-quality lighting.

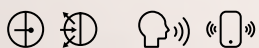

The Family

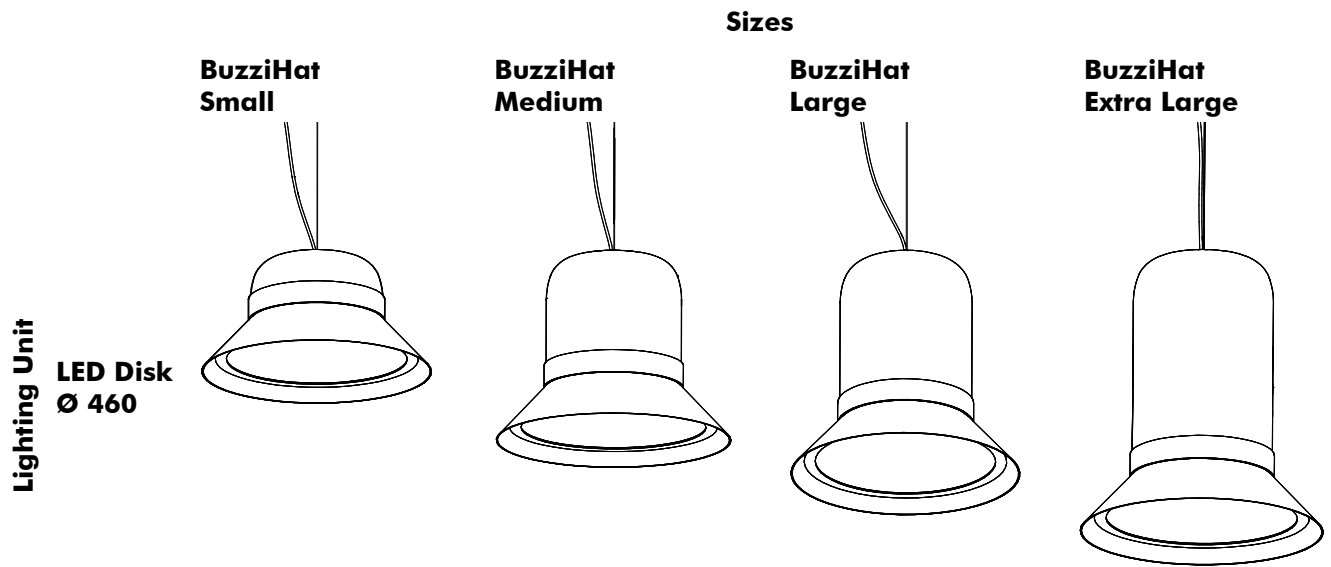

Required order information

1. Size
2. Fabric (CAT -> Collection -> Color)
3. Color Metal Shade
4. Color Decorative Ring
5. Mounting Option

Lighting Data

Lighting Unit



The PMMA diffuser ensures an optimal light spread and efficiency. It creates a very diffuse light surface without any dottiness.

Lighting specifications

BuzziHat Small

Lighting Unit	Voltage	Wattage	Light Output Luminaire	Efficacy (Lm/W)	CRI	Dimming	Color Temperature	UGR	Standard (stock) On request (>LT)	Color Power Cable	Color Ceiling Canopy	Color Metal Shade and Ring	Fabric Collection	Fabric Color	Mounting Option
LED Disk Ø460	120-277V	26W	2000 Lm	77	80	1-10V	3000K	20	Standard	Transparent	White	Black, White, Beige Red, Gold	Use color codes below	Use color codes below	1 cable of 78.74" Alu or Black 1 cables of 196.85" Alu or Black

BuzziHat Medium

Lighting Unit	Voltage	Wattage	Light Output Luminaire	Efficacy (Lm/W)	CRI	Dimming	Color Temperature	UGR	Standard (stock) On request (>LT)	Color Power Cable	Color Ceiling Canopy	Color Metal Shade and Ring	Fabric Collection	Fabric Color	Mounting Option
LED Disk Ø460	120-277V	26W	2000 Lm	77	80	1-10V	3000K	20	Standard	Transparent	White	Black, White, Beige Red, Gold	Use color codes below	Use color codes below	1 cable of 78.74" Alu or Black 1 cables of 196.85" Alu or Black

BuzziHat Large

Lighting Unit	Voltage	Wattage	Light Output Luminaire	Efficacy (Lm/W)	CRI	Dimming	Color Temperature	UGR	Standard (stock) On request (>LT)	Color Power Cable	Color Ceiling Canopy	Color Metal Shade and Ring	Fabric Collection	Fabric Color	Mounting Option
LED Disk Ø460	120-277V	26W	2000 Lm	77	80	1-10V	3000K	20	Standard	Transparent	White	Black, White, Beige Red, Gold	Use color codes below	Use color codes below	1 cable of 78.74" Alu or Black 1 cables of 196.85" Alu or Black

BuzziHat Extra Large

Lighting Unit	Voltage	Wattage	Light Output Luminaire	Efficacy (Lm/W)	CRI	Dimming	Color Temperature	UGR	Standard (stock) On request (>LT)	Color Power Cable	Color Ceiling Canopy	Color Metal Shade and Ring	Fabric Collection	Fabric Color	Mounting Option
LED Disk Ø460	120-277V	26W	2000 Lm	77	80	1-10V	3000K	20	Standard	Transparent	White	Black, White, Beige Red, Gold	Use color codes below	Use color codes below	1 cable of 78.74" Alu or Black 1 cables of 196.85" Alu or Black

cULus listed

Photometric Data

BuzziHat LED Disk Ø 460

BuzziHat White Shade Cartesian Diagram

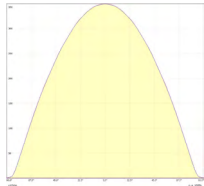

BuzziHat White Shade Polar curve

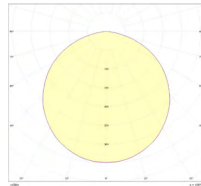

BuzziHat Black Shade Cartesian diagram

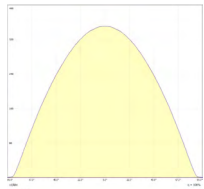

BuzziHat Black Shade Polar curve

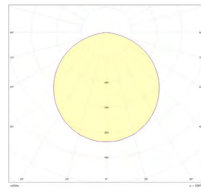

Tips and Tricks - Light Options

To enlight your workplace with optimal lux levels take following measurements into account:

Office,
Meeting room

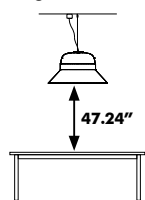

500 Lux

Reception desk, lounge, classroom

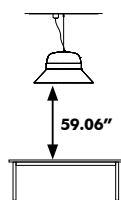

300 Lux

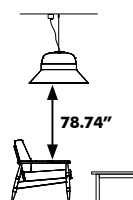

200 Lux

Entrance Hall

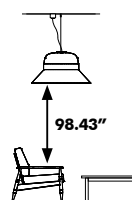

100 Lux

To ensure a continuous light spread into account take following distances inbetween the BuzziHats

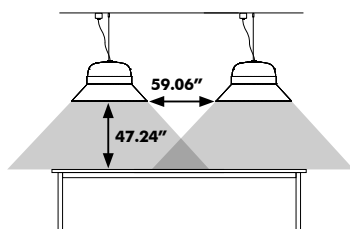

500 Lux

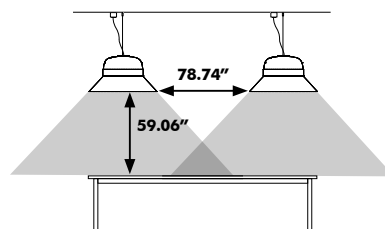

300 Lux

According to EN12464

Product Data

Fixing System

Fixing System BuzziHat

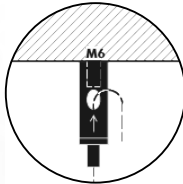

BuzziHat is suspended on 1 cable of 78.74" or 196.85" black or alu colored cables, with fixing system screw.

▲ If installing on suspended ceiling, verify load capacity prior to installation.

Acoustic Body



The acoustic body is upholstered in a chosen fabric.

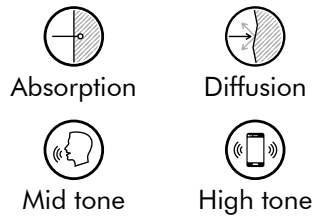

Metal Shade and Ring



The powder coated metal shade and decorative ring are available in 4 colors: Black (RAL 9005), White (RAL 9010), Beige Red (RAL 3012) or Gold

Mix and Match



Customize your BuzziHat by mixing and matching the color of the ring, the shade and the upholstery fabric.

Acoustics

BuzziHat

Equivalent sound absorption area in m² per object

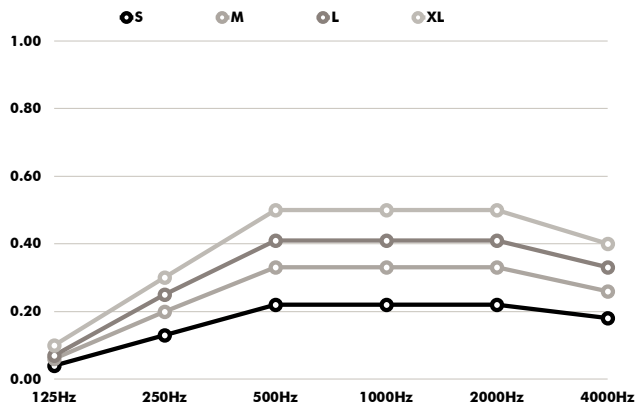

Hz	S Aeq/m ²	M Aeq/m ²	L Aeq/m ²	XL Aeq/m ²
125	0.04	0.06	0.07	0.10
250	0.13	0.20	0.25	0.30
500	0.22	0.33	0.41	0.50
1000	0.22	0.33	0.41	0.50
2000	0.22	0.33	0.41	0.50
4000	0.18	0.26	0.33	0.40

Dimensions

BuzziHat S

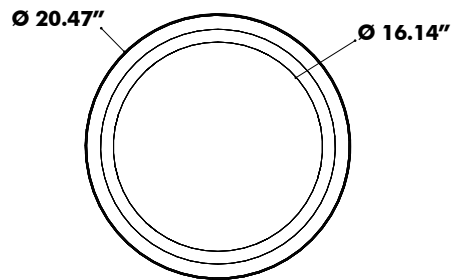
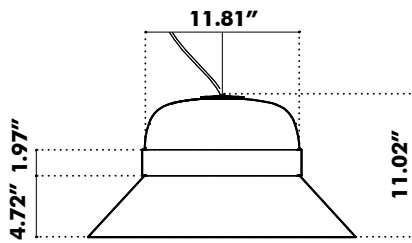

BuzziHat M

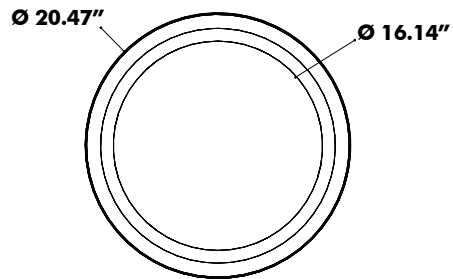
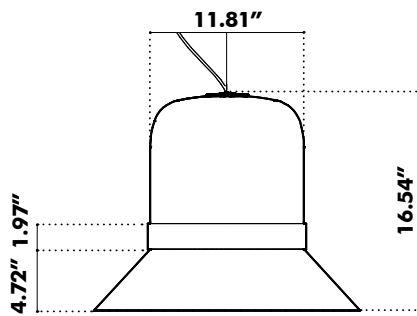

BuzziHat L

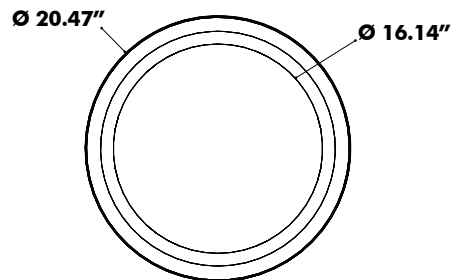
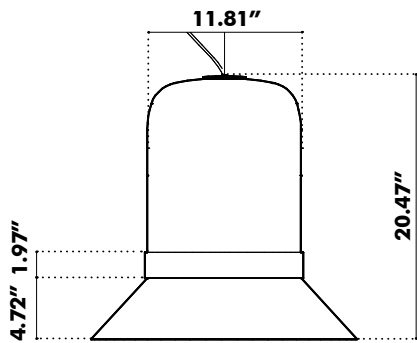

BuzziHat XL

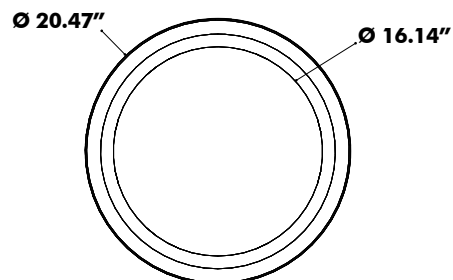
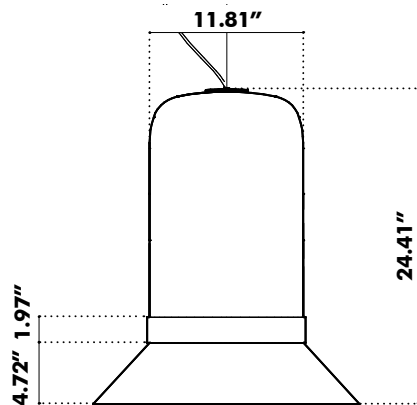

Suspension Set

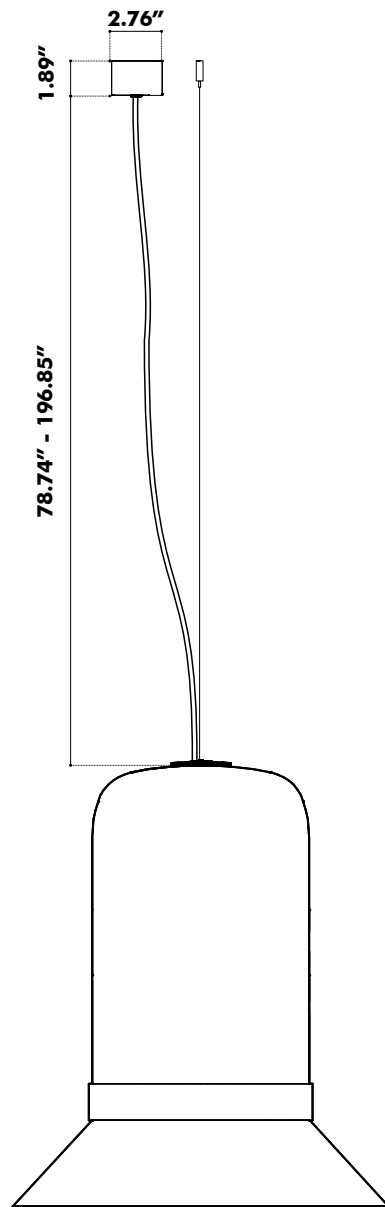

Weights

BuzziHat Small

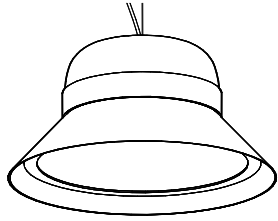

14.33 lbs

BuzziHat Medium

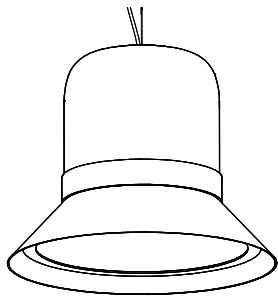

15.43 lbs

BuzziHat Large

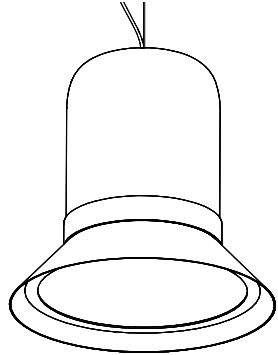

16.53 lbs

BuzziHat Extra Large

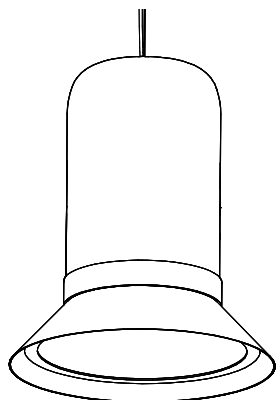

17.64 lbs

Fabrics

Fabric (45 colors)

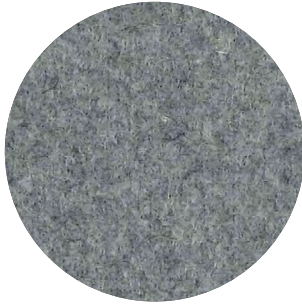

Category A

Composition 70% Recycled Wool, 25% Recycled Polyacryl,
5% Recycled Other Fabrics

Weight 405 g/m² | 11.94 oz/yd²

Abrasion resistance 40.000 Martindale, 50,000 Wyzenbeek

Flammability EU: EN 1021.1/2006 | BS EN 1021.1/2006 (cigarette).
EN 1021.2/2006 | BS EN 1021.2/2006 (match)
USA: CAL TB 117 | ASTM E84 CLASS A

Fastness to light EU: 4 | USA 4

Fastness to rubbing EU: Wet 3-4 | Dry 4-5

Fastness to crocking USA: Wet 5 | Dry 5



Trevira CS+ | CS (47 colors)

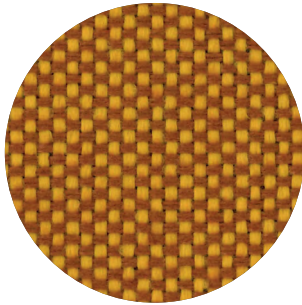

Category A

Weight 420 g/m² | 12.39 oz/yd²

Composition 100% Polyester, Trevira CS

Abrasion resistance 100.000 Martindale, 90,000 Wyzenbeek

Flammability BS 5852 part II: CRIB 5 | BS 7176 Medium Hazard
USA: CAL TB 117 | M1 | B1 | EN 1021/1-2 | C1 |
IMO Res. A652 (16)

Fastness to light EU: 6 | USA 5

Fastness to rubbing EU: Wet 4-5 | Dry 4-5

Fastness to crocking USA: Wet 5 | Dry 5



Revive 1 (25 colors)

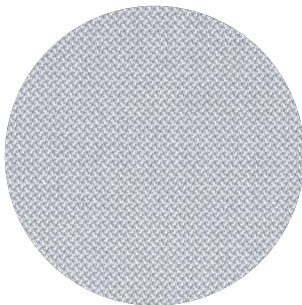

Category A

Composition 100% recycled polyester FR

Weight 430 g/lin.m

Abrasion resistance 60.000 Martindale rubs, EN ISO 12947

Flammability EN 1021-1/2 | DIN 4102 B1 | Önorm B1/Q1
UNI 9175 1IM | US Cal. Tech. Bull. 117
IMO A.652 (16)

Fastness to light Note 5-7, ISO 105-B02

Fastness to rubbing (ISO) dry 5, wet 4-5

Pilling Note 4-5, EN ISO 12945



kvadrat

Velvet (12 colors)

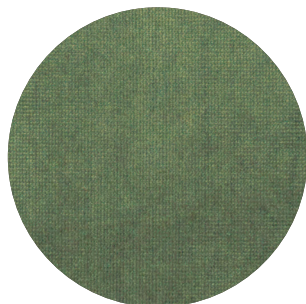

Category B
Composition 100% PES
Weight 375 g/m² | 11.06 oz/yd²
Abrasion resistance > 100.000 Martindale
Fastness to light EU: 4-5
Fastness to rubbing EU: Wet 4 | Dry 4-5
Pilling EU: 4-5

Clara 2 (24 colors)

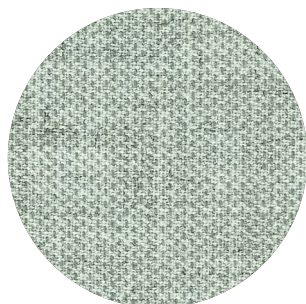

Category B
Composition 92% new wool, 8% nylon
Weight 400 g/lin.m
Abrasion resistance 80.000 Martindale rubs, EN ISO 12947
Flammability EN 1021-1/2 | BS 5852, ignition source 2-3 | DIN 4102 B2
NF D 60 013 | UNI 9175 1IM | US Cal. Tech. Bull. 117, Sec. E
NFPA 260 | IMO A.652(16)
Fastness to light Note 5-7, ISO 105-B02
Fastness to rubbing (ISO) dry 4-5, wet 4
Pilling Note 4, EN ISO 12945



kvadrat

Remix 3 (73 colors)



Category B
Composition 90% new wool, 10% nylon
Weight 415 g/lin.m
Abrasion resistance 100.000 Martindale rubs, EN ISO 12947
Flammability EN 1021-1/2 | BS 5852 part 1
Önorm B1/Q1 | NF D 60 013 | UNI 9175, 1IM
AS/NZS 1530.3 | Cal. Tech. Bull. 117-2013
NFPA 260 | IMO FTP Code 2010:Part 8
Fastness to light Note 5-7, ISO 105-B02
Fastness to rubbing (ISO) dry 4-5, wet 4
Pilling Note 4, EN ISO 12945



kvadrat

Hero 2 (33 colors)

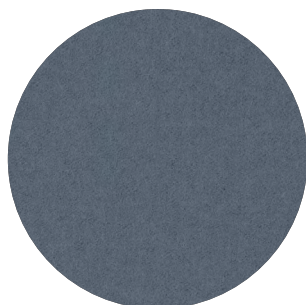

Category C
Composition 97% new wool, 3% nylon
Weight 580 g/lin.m
Abrasion resistance 45.000 Martindale rubs, EN ISO 12947
Flammability EN 1021-1/2 | DIN 4102 B2 | NF D 60 013
UNI 9175 1IM | US Cal. Bull. 117-2013 | NFPA 260
IMO A.652 (16)
Fastness to light Note 5-6, ISO 105-B02
Fastness to rubbing (ISO) dry 4-5, wet 4-5
Pilling Note 3-4, EN ISO 12945



kvadrat

Tonus 4 (47 colors)

kvadrat



Category D

Composition 90% new wool, 10% Helanca

Weight 665 g/lin.m

Abrasion resistance 100.000 Martindale rubs, EN ISO 12947

Flammability EN 1021-1/2 | BS 5852 part 1 | DIN 4102 B2

Önorm B1/Q1 | NF D 60 013 | UNI 9175 11M

US Cal. Bull. 117-2013 | NFPA 260 | IMO A.652 (16)

Fastness to light Note 5-7, ISO 105-B02

Fastness to rubbing (ISO) dry 3-5, wet 3-5

Pilling Note 3, EN ISO 12945



Memory 2 (20 colors)

kvadrat

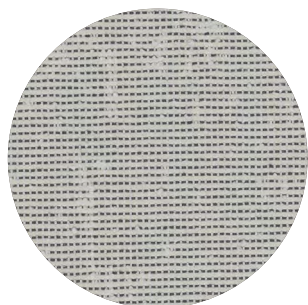

Category E

Composition 100% Trevira CS

Weight 700 g/lin.m

Abrasion resistance

35.000 rubs acc. to the Martindale method, EN ISO 12947

Flammability EN 1021-1/2 | DIN 4102 B1 | Önorm B1/Q1

NF D 60 013 | NF P 92 507 M1 | UNI 9175 11M

UNI 9177 classe 1 | US Cal. Tech. Bull. 117

IMO A.652 (16)

Fastness to light Note 5-8, ISO 105-B02

Fastness to rubbing (ISO) dry 4-5, wet 4-5

Pilling Note 4, EN ISO 12945

