BuzziLand

Product Specification Sheet

This document contains technical information about the BuzziLand



Dampen sounds without losing out on chic design

Large office spaces or residential lofts often echo. This is an irritating problem which does little to encourage hard work or make a space cosy. BuzziSpace has developed the BuzziLand and BuzziPod in sound-insulating material: stick them to the ceiling or walls to dampen sounds without losing out on chic design.

Design by BuzziSpace Studio

General

- BuzziLand
- Shape: Oval, Round
- Pattern: Oval: Flat, Rib
Round: Flat, 3D Rib, 3D Drop, 3D Leaf
- Fixing: Wall | Pendant

- Core: Honeycomb cardboard
- Filling: Acoustic foam
- Upholstery: Fabric
- Back: Black textile

- Fixation: wall mounted | ceiling pendant: Fixing System Screw or Fixing System Magnet
- Black or Alu cables 2 - 5 m | 78.74" - 196.85"

- ⚠ If installing on suspended ceiling, verify load capacity prior to installation.

Certifications



Acoustics



Absorption



Diffusion



Mid tone



High tone

Content

Configurations	3	Fixing Systems	6
Patterns	4	Dimensions	7
Fabrics	5	Acoustics	12

Configurations

BuzziLand Oval

- ◆ S, M, L, XL
- ◆ Pattern: Flat, 3D Rib
- ◆ Fixing: wall mounted or ceiling suspended

- ◆ Core: Honeycomb cardboard
- ◆ Filling: Acoustic foam
- ◆ Cover: Fabric
- ◆ Back: Black textile

- ✂ S: H 80 cm W 120 cm | H 31.50" W 47.24"
- ✂ M: H 80 cm W 160 cm | H 31.50" W 62.99"
- ✂ L: H 100 cm W 180 cm | H 39.37" W 70.87"
- ✂ XL: H 120 cm W 200 cm | H 47.24" W 78.74"

- ⚖ Flat | 3D: S: 4,5 kg | 9.92 lbs
- M: 5,8 kg | 12.79 lbs
- L: 7,5 kg | 16.53 lbs
- XL: 9,5 kg | 20.94 lbs

- ⋮ Fixation: wall mounted: Fixing System Wall
- ceiling suspended: Fixing System Screw
- Fixing System Magnet
- Black or Alu cables 2 - 5 m | 78.74" - 196.85"

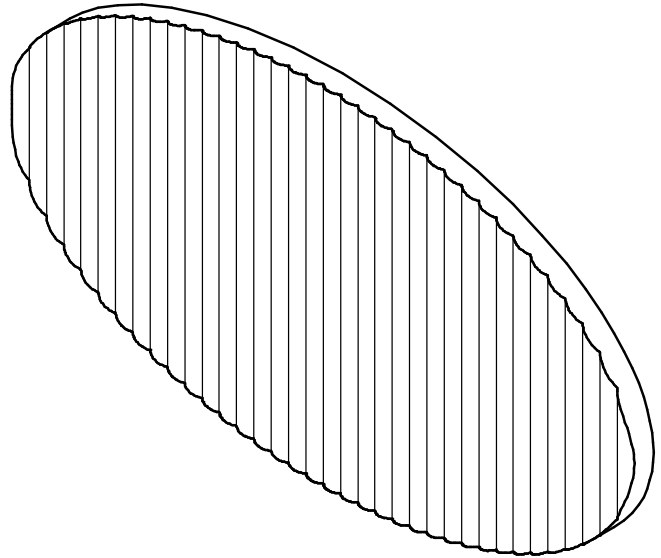

BuzziLand Round

- ◆ S, M, L
- ◆ Pattern: Flat | 3D: Rib, Drop, Leaf

- ◆ Core: Honeycomb cardboard
- ◆ Filling: Acoustic foam
- ◆ Cover: Fabric
- ◆ Back: Black textile

- ✂ S: Ø 80 cm | Ø 31.50"
- ✂ M: Ø 100 cm | Ø 39.37"
- ✂ L: Ø 120 cm | Ø 47.24"

- ⚖ Flat | 3D: S: 3,3 kg | 7.28 lbs
- M: 4,6 kg | 10.14 lbs
- L: 6,3 kg | 13.89 lbs

- ⋮ Fixation: wall mounted: Fixing System Wall
- ceiling suspended: Fixing System Screw
- Fixing System Magnet
- Black or Alu cables 2 - 5 m | 78.74" - 196.85"

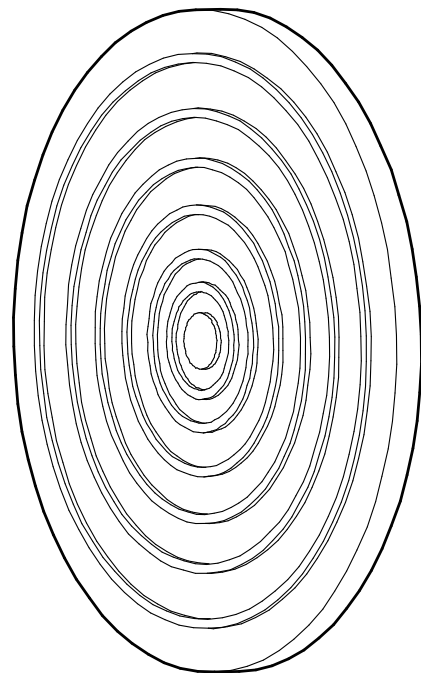

Patterns

Oval

Flat

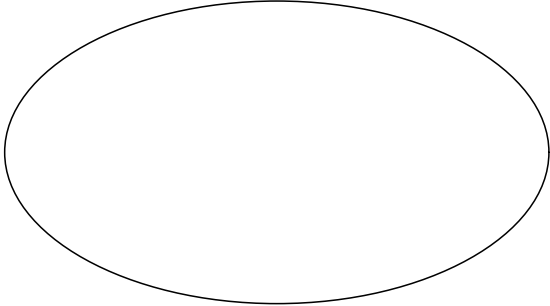

Rib

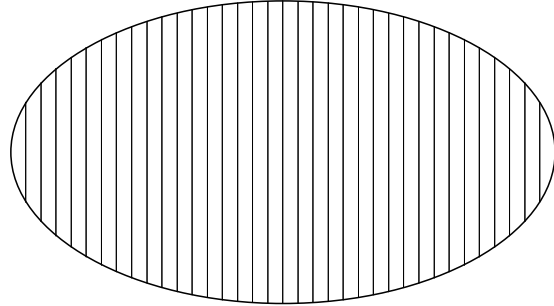

Round

Flat

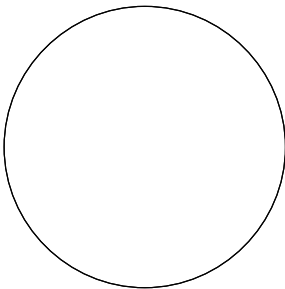

Rib

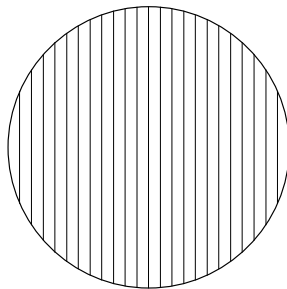

Drop

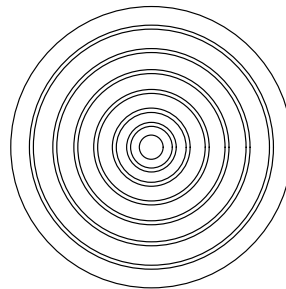

Leaf

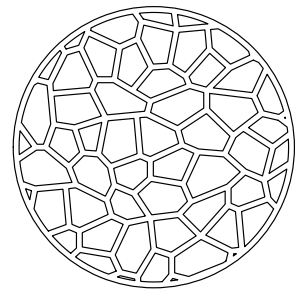

Fabrics

Fabric (45 colors)

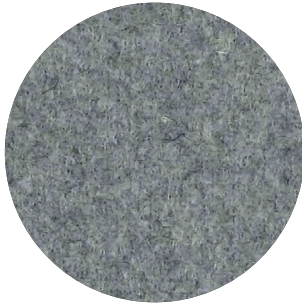

Category A

Composition 70% Recycled Wool, 25% Recycled Polyacryl,
5% Recycled Other Fabrics

Weight 405 g/m² | 11.94 oz/yd²

Abrasion resistance 40.000 Martindale, 50,000 Wyzenbeek

Flammability EU: EN 1021.1/2006 | BS EN 1021.1/2006 (cigarette).
EN 1021.2/2006 | BS EN 1021.2/2006 (match)
USA: CAL TB 117 | ASTM E84 CLASS A

Fastness to light EU: 4 | USA 4

Fastness to rubbing EU: Wet 3-4 | Dry 4-5

Fastness to crocking USA: Wet 5 | Dry 5



Trevira CS+ | CS (47 colors)

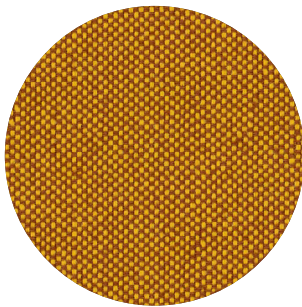

Category A

Weight 420 g/m² | 12.39 oz/yd²

Composition 100% Polyester, Trevira CS

Abrasion resistance 100.000 Martindale, 90,000 Wyzenbeek

Flammability BS 5852 part II: CRIB 5 | BS 7176 Medium Hazard
USA: CAL TB 117 | M1 | B1 | EN 1021/1-2 | C1 |
IMO Res. A652 (16)

Fastness to light EU: 6 | USA 5

Fastness to rubbing EU: Wet 4-5 | Dry 4-5

Fastness to crocking USA: Wet 5 | Dry 5



Revive 1 (25 colors)

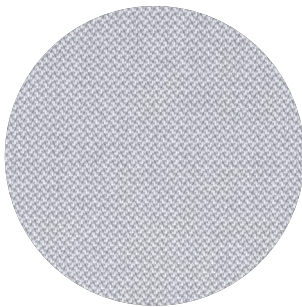

Category A

Composition 100% recycled polyester FR

Weight 430 g/lin.m

Abrasion resistance 60.000 Martindale rubs, EN ISO 12947

Flammability EN 1021-1/2 | DIN 4102 B1 | Önorm B1/Q1
UNI 9175 1IM | US Cal. Tech. Bull. 117
IMO A.652 (16)

Fastness to light Note 5-7, ISO 105-B02

Fastness to rubbing (ISO) dry 5, wet 4-5

Pilling Note 4-5, EN ISO 12945



kvadrat

Clara 2 (24 colors)

kvadrat

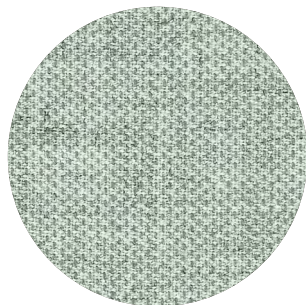

Category B

Composition 92% new wool, 8% nylon

Weight 400 g/lin.m

Abrasion resistance 80.000 Martindale rubs, EN ISO 12947

Flammability EN 1021-1/2 | BS 5852, ignition source 2-3 | DIN 4102 B2
NF D 60 013 | UNI 9175 11M | US Cal. Tech. Bull. 117, Sec. E
NFPA 260 | IMO A.652(16)

Fastness to light Note 5-7, ISO 105-B02

Fastness to rubbing (ISO) dry 4-5, wet 4

Pilling Note 4, EN ISO 12945



Remix 3 (73 colors)

kvadrat



Category B

Composition 90% new wool, 10% nylon

Weight 415 g/lin.m

Abrasion resistance 100.000 Martindale rubs, EN ISO 12947

Flammability EN 1021-1/2 | BS 5852 part 1
Önorm B1/Q1 | NF D 60 013 | UNI 9175, 11M
AS/NZS 1530.3 | Cal. Tech. Bull. 117-2013
NFPA 260 | IMO FTP Code 2010:Part 8

Fastness to light Note 5-7, ISO 105-B02

Fastness to rubbing (ISO) dry 4-5, wet 4

Pilling Note 4, EN ISO 12945



Hero 2 (33 colors)

kvadrat

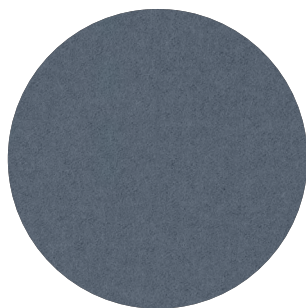

Category C

Composition 97% new wool, 3% nylon

Weight 580 g/lin.m

Abrasion resistance 45.000 Martindale rubs, EN ISO 12947

Flammability EN 1021-1/2 | DIN 4102 B2 | NF D 60 013
UNI 9175 11M | US Cal. Bull. 117-2013 | NFPA 260
IMO A.652 (16)

Fastness to light Note 5-6, ISO 105-B02

Fastness to rubbing (ISO) dry 4-5, wet 4-5

Pilling Note 3-4, EN ISO 12945



Tonus 4 (47 colors)

kvadrat



Category D

Composition 90% new wool, 10% Helanca

Weight 665 g/lin.m

Abrasion resistance 100.000 Martindale rubs, EN ISO 12947

Flammability EN 1021-1/2 | BS 5852 part 1 | DIN 4102 B2

Önorm B1/Q1 | NF D 60 013 | UNI 9175 11M

US Cal. Bull. 117-2013 | NFPA 260 | IMO A.652 (16)

Fastness to light Note 5-7, ISO 105-B02

Fastness to rubbing (ISO) dry 3-5, wet 3-5

Pilling Note 3, EN ISO 12945



Memory 2 (20 colors)

kvadrat

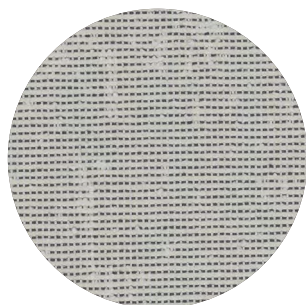

Category E

Composition 100% Trevira CS

Weight 700 g/lin.m

Abrasion resistance

35.000 rubs acc. to the Martindale method, EN ISO 12947

Flammability EN 1021-1/2 | DIN 4102 B1 | Önorm B1/Q1

NF D 60 013 | NF P 92 507 M1 | UNI 9175 11M

UNI 9177 classe 1 | US Cal. Tech. Bull. 117

IMO A.652 (16)

Fastness to light Note 5-8, ISO 105-B02

Fastness to rubbing (ISO) dry 4-5, wet 4-5

Pilling Note 4, EN ISO 12945



Fixing Systems

Fixing System Wall (optional)

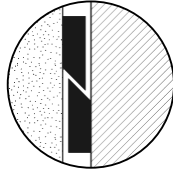
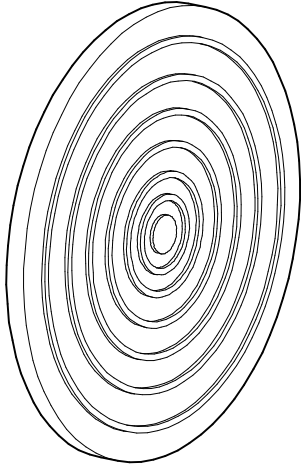

2x2 wooden brackets (excl. screws)
(No wall mounting possible for Virgule)

Fixing System Ceiling Suspended (optional)

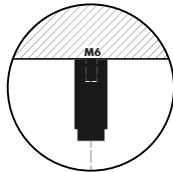
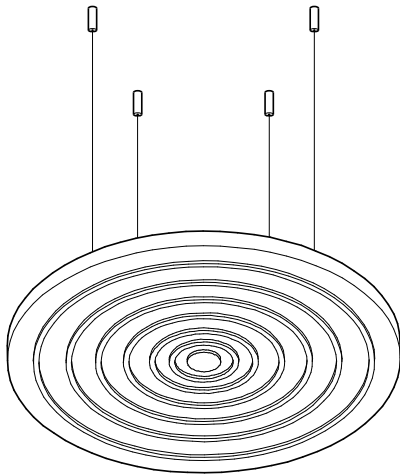

Fixing System Screw

4 cables of 2 - 5 m | 78.74" - 196.85"
Black or aluminium coloured cables
(Buzziland Virgule: 3 cables)

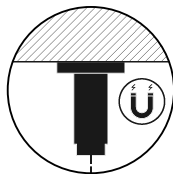
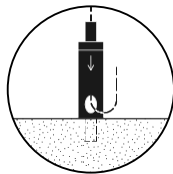

Fixing System Magnet

4 cables of 2 - 5 m | 78.74" - 196.85"
Black or aluminium coloured cables
(Buzziland Virgule: 3 cables)

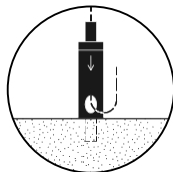

*1 magnet (Ø 3,2 cm H 0,8 cm | Ø 1.26" H 0.31") can take up to 10 kg | 22.05 lbs when hanging on a solid metal surface.

Dimensions

Oval

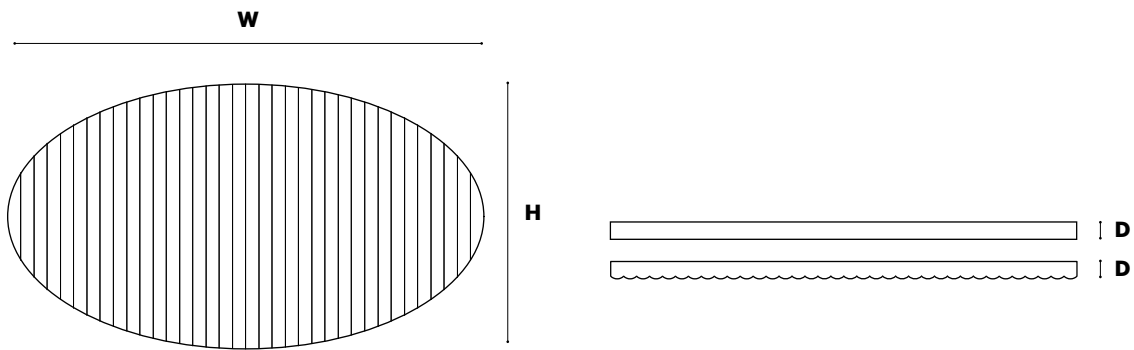

S	H 80 cm	W 120 cm	Flat + 3D: D 6,5 cm
	H 31.50"	W 47.24"	Flat + 3D: D 2.56"
M	H 80 cm	W 160 cm	Flat + 3D: D 6,5 cm
	H 31.50"	W 62.99"	Flat + 3D: D 2.56"
L	H 100 cm	W 180 cm	Flat + 3D: D 6,5 cm
	H 39.37"	W 70.87"	Flat + 3D: D 2.56"
XL	H 120 cm	W 200 cm	Flat + 3D: D 6,5 cm
	H 47.24"	W 78.74"	Flat + 3D: D 2.56"

Round

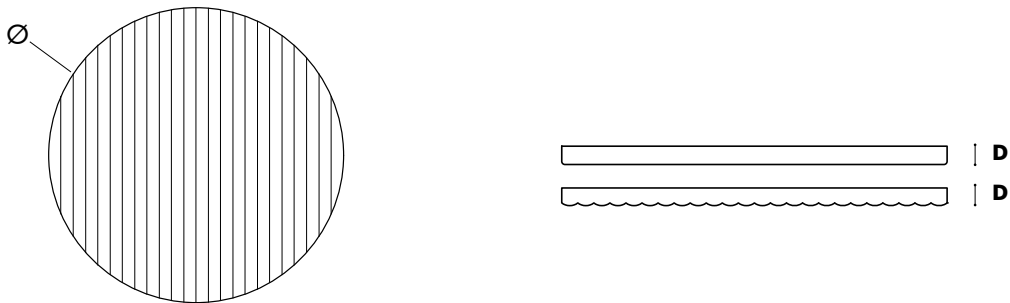

S	Ø 80 cm	Flat + 3D: D 6,5 cm
	Ø 31.50"	Flat + 3D: D 2.56"
M	Ø 100 cm	Flat + 3D: D 6,5 cm
	Ø 39.37"	Flat + 3D: D 2.56"
L	Ø 120 cm	Flat + 3D: D 6,5 cm
	Ø 47.24"	Flat + 3D: D 2.56"

Dimensions Fixing System Wall

Oval

S
 H 80 cm W 120 cm
 H 31.50" W 47.24"

Horizontal use

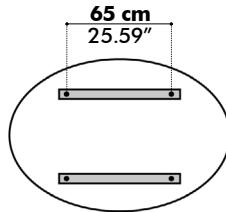
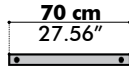

Vertical use

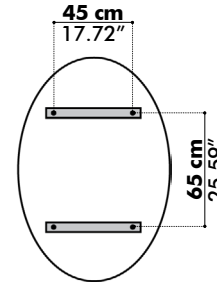
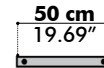

M
 H 80 cm W 160 cm
 H 31.50" W 62.99"

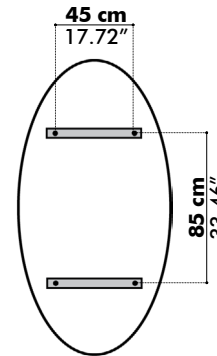
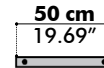
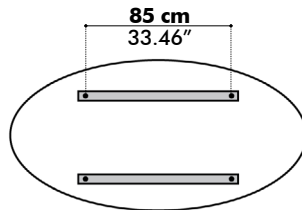
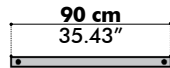

L
 H 100 cm W 180 cm
 H 39.37" W 70.87"

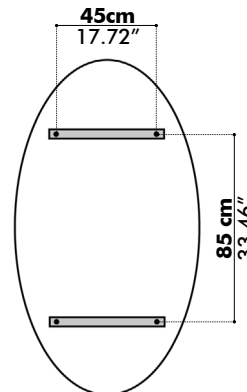
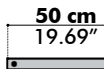
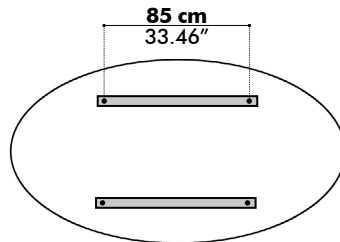
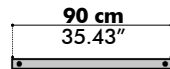

XL
 H 120 cm W 200 cm
 H 47.24" W 78.74"

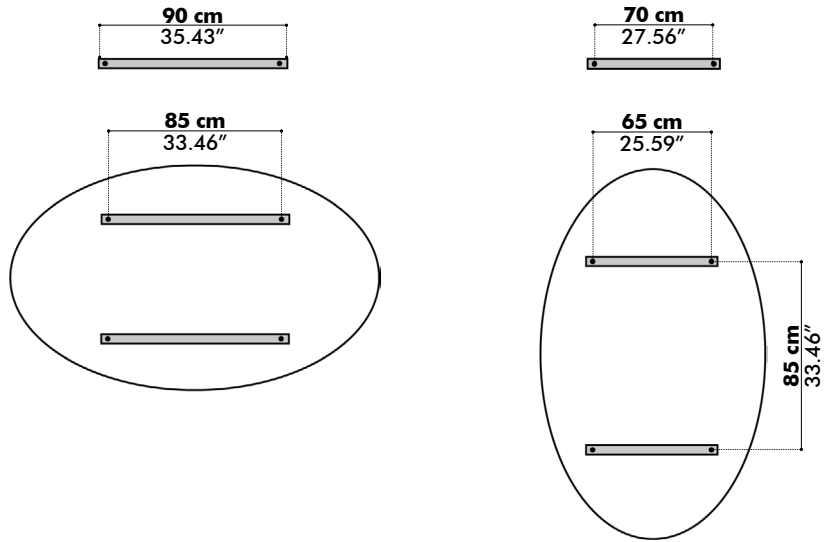

Round

S
 Ø 80 cm
 Ø 31.50"

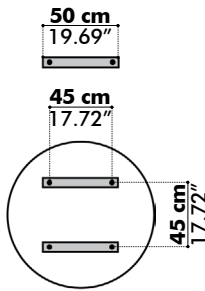

M
 Ø 100 cm
 Ø 39.37"

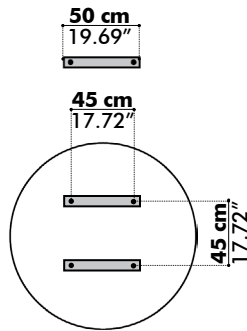

L
 Ø 120 cm
 Ø 47.24"

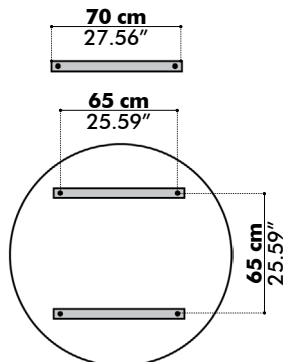

Dimensions Fixing System Suspended

Oval

S

H 80 cm W 120 cm
H 31.50" W 47.24"

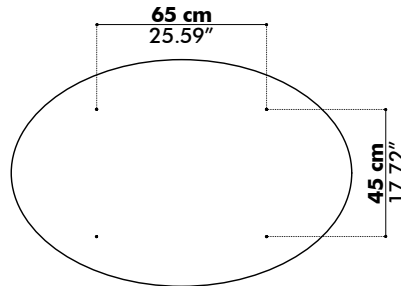

M

H 80 cm W 160 cm
H 31.50" W 62.99"

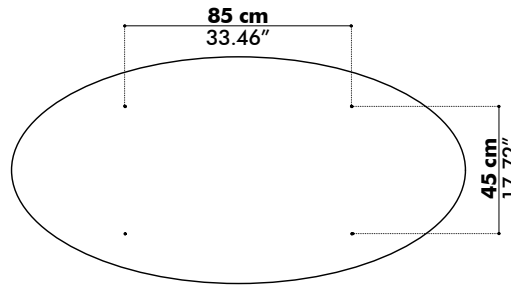

L

H 100 cm W 180 cm
H 39.37" W 70.87"

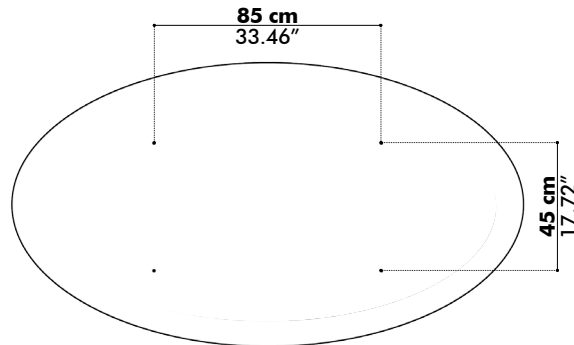

XL

H 120 cm W 200 cm
H 47.24" W 78.74"

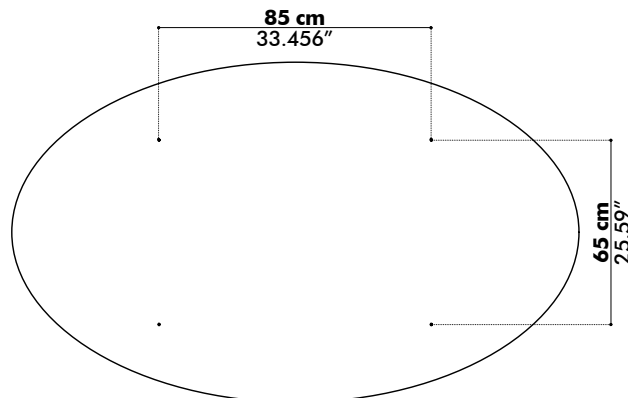

Round

S
Ø 80 cm
Ø 31.50"

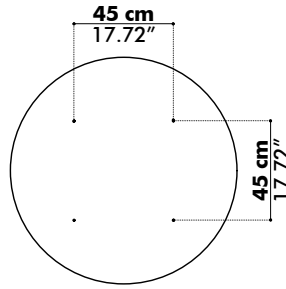

M
Ø 100 cm
Ø 39.37"

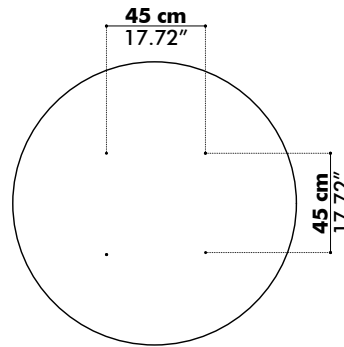

L
Ø 120 cm
Ø 47.24"

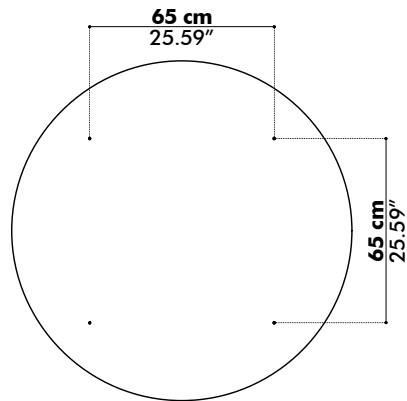

Acoustics

BuzziLand Ceiling Oval

Equivalent sound absorption area in m² per object

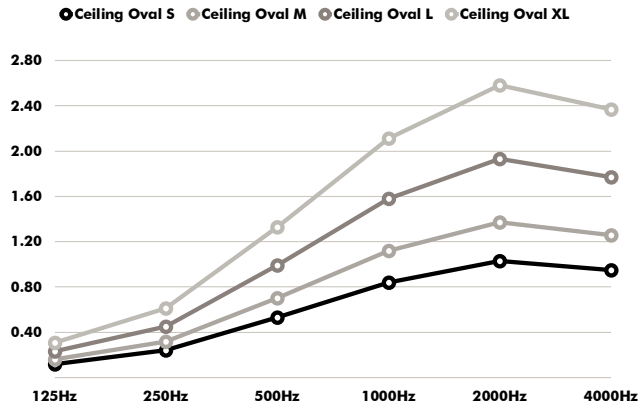

Hz	Oval S Aeq/m ²	Oval M Aeq/m ²	Oval L Aeq/m ²	Oval XL Aeq/m ²
125	0.12	0.16	0.23	0.31
250	0.24	0.32	0.45	0.61
500	0.53	0.70	0.99	1.33
1000	0.84	1.12	1.58	2.11
2000	1.03	1.37	1.93	2.58
4000	0.95	1.26	1.77	2.37

BuzziLand Ceiling Round

Equivalent sound absorption area in m² per object

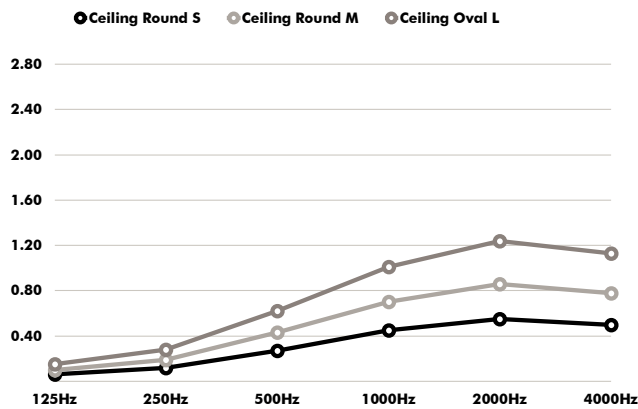

Hz	Round S Aeq/m ²	Round M Aeq/m ²	Round L Aeq/m ²
125	0.06	0.10	0.15
250	0.12	0.19	0.28
500	0.27	0.43	0.62
1000	0.45	0.70	1.01
2000	0.55	0.86	1.24
4000	0.50	0.78	1.13

BuzziLand Wall Oval

Equivalent sound absorption area in m² per object

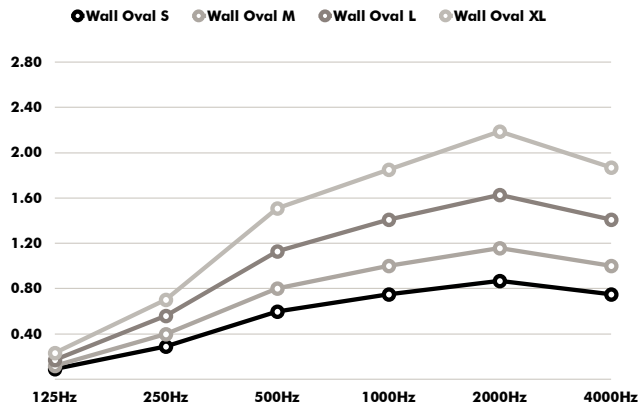

Hz	Oval S Aeq/m ²	Oval M Aeq/m ²	Oval L Aeq/m ²	Oval XL Aeq/m ²
125	0.09	0.12	0.17	0.23
250	0.29	0.40	0.56	0.70
500	0.60	0.80	1.13	1.51
1000	0.75	1.00	1.41	1.85
2000	0.87	1.16	1.63	2.19
4000	0.75	1.00	1.41	1.87

BuzziLand Wall Round

Equivalent sound absorption area in m² per object

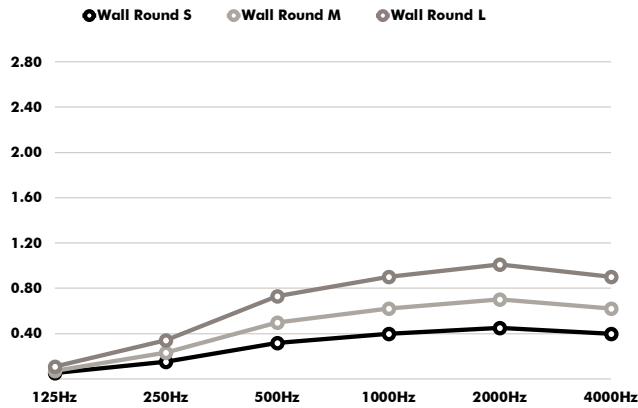

Hz	Round S Aeq/m ²	Round M Aeq/m ²	Round L Aeq/m ²
125	0.05	0.07	0.11
250	0.15	0.23	0.34
500	0.32	0.50	0.73
1000	0.40	0.62	0.90
2000	0.45	0.70	1.01
4000	0.40	0.62	0.90

BuzziLand

Absorption coefficient

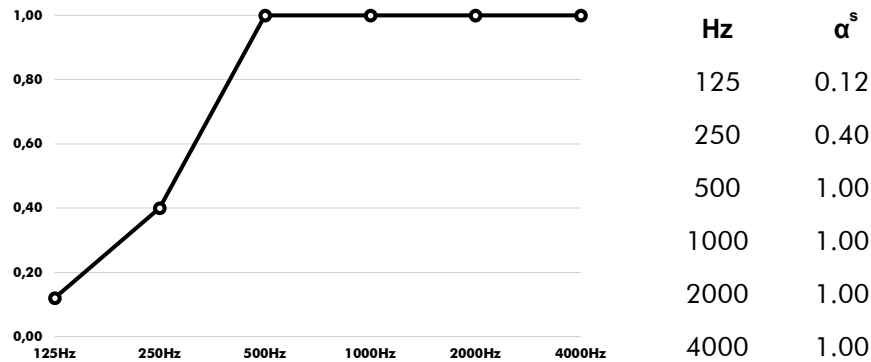

Absorption Values

α_w
(ISO 11654) 0.75 Class C

NRC
(ASTM - C423) 0.85 Class B

SAA
(ASTM - C423) 0.85 Class B

Glossary

All calculations are based on accredited lab measurements, official document available on www.buzzi.space

Definitions

α	Weighted absorption coefficient	(ISO 11654)
NRC	Noise reduction coefficient	(ASTM - C423)
SAA	Sound absorption average	(ASTM - C423)

Classification of sound absorbers NEN-EN-ISO 11654

A	0.90 0.95 1.0
B	0.80 0.85
C	0.60 0.65 0.70 0.75
D	0.03 0.55
E	0.15 0.25