



## Styles

# Muffle Free-Hanging Screen PET



Small Hexagons



Triangle



Circles Mixed



Large Circles



Castle Gate

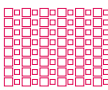

Mixed Squares

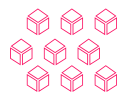

Large Hexagons

**Muffle Free-Hanging Screen PET** introduces a simple yet effective way of settling down loud and busy environments. Designed primarily for offices and reception areas, the hanging acoustic screens help to absorb ambient background noise. A reduction in the levels of reverberation helps to reduce the number of distractions caused by both internal and external factors.

### Advantages:

- Wide range of colours available
- Ideal for multiple indoor environments
- Fixings included
- Safe, non-toxic and non-irritant

# Product Variations & Dimensions



**SMALL HEXAGONS**

2400 x 1200 x 12 (mm)  
2400 x 1200 x 24 (mm)



**LARGE HEXAGONS**

2400 x 1200 x 12 (mm)  
2400 x 1200 x 24 (mm)

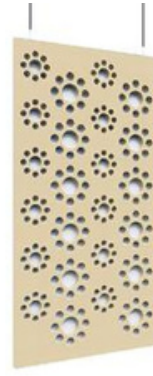

**MIXED CIRCLES**

2400 x 1200 x 12 (mm)  
2400 x 1200 x 24 (mm)



**MIXED SQUARES**

2400 x 1200 x 12 (mm)  
2400 x 1200 x 24 (mm)



**CASTLE GATE**

2400 x 1200 x 12 (mm)  
2400 x 1200 x 24 (mm)



**LARGE CIRCLES**

2400 x 1200 x 12 (mm)  
2400 x 1200 x 24 (mm)



**TRIANGLES**

2400 x 1200 x 12 (mm)  
2400 x 1200 x 24 (mm)

## Product Specifications



### Fire

The PET material has been tested to EN13501-:2007+A1:2009 s1, d0 / ASTM E84-2019 B Class A



### Environmental

65% Recycled PET Fibre | 35% Virgin Fibre  
VOC Emissions <0.02mg/M2  
Formaldehyde 0.00 UG/G  
OKE TEX Standard 100 - Class 1  
100% Recyclable Content



### Weight

12 mm PET (m2) | 2.4kg  
24 mm PET (m2) | 4.8kg  
Note: all weights are approximate



### Acoustic Performance

Acoustic Class | Up to CLASS A  
See the next page for more acoustic information.

# Acoustic Performance

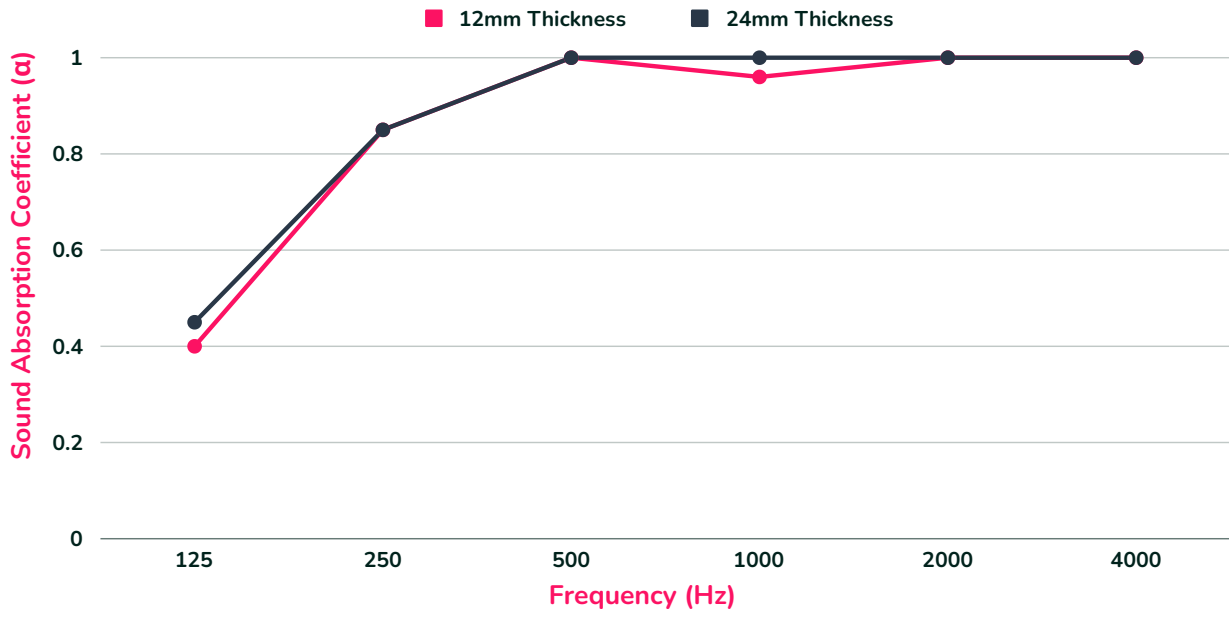

Muffle Free-Hanging Acoustic Screen 12mm & 24mm							
Frequency (Hz)	125	250	500	1000	2000	4000	NRC
12mm Thickness	0.40	0.85	1.00	0.96	1.00	1.00	0.95
24mm Thickness	0.45	0.85	1.00	1.00	1.00	1.00	1.00



# Installation

## Step 1

Attach and screw the softfit into to the ceiling with an appropriate screw.

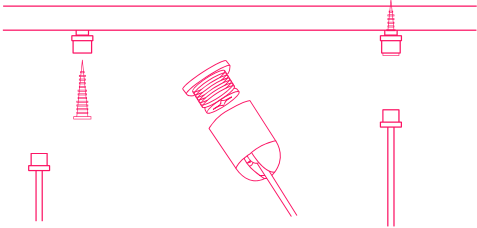

## Step 2

Slide the end of the wire through the anchor foot attachment to your desired length and cut off any excess.

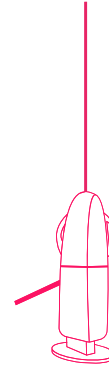

## Step 3

Use the lip on the Anchor foot attachment to slide it into the channel.

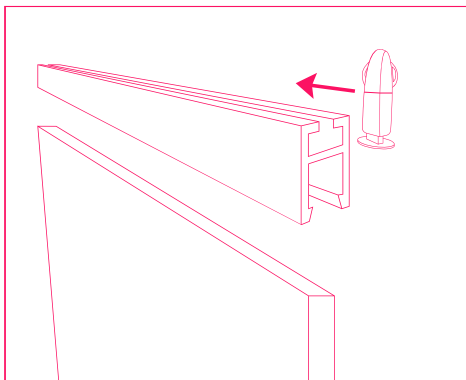

## Step 4

Slide the hanging screen through the channel.

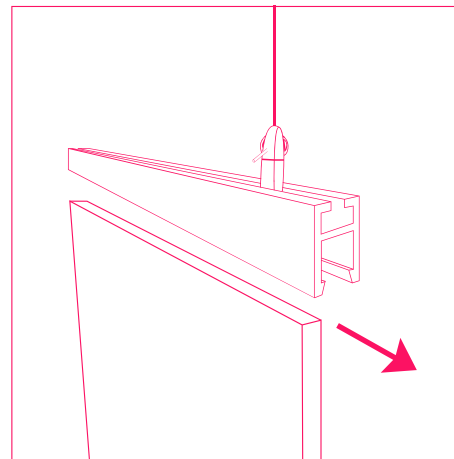

# Colours



Ice White

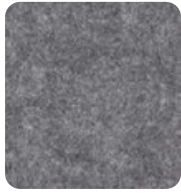

Slate Grey



Charcoal Grey

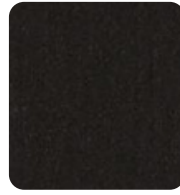

Black

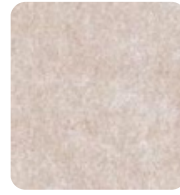

Opal



Sand



Soft Blue



Teal



Yellow

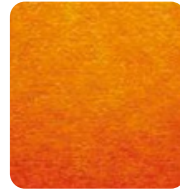

Orange

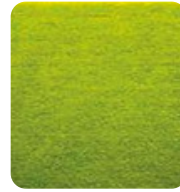

Fuzzy Green



Cherry Red



Midnight Blue



Deep Blue

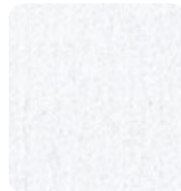

White

# Product Care

## Delivery, Storage & Handling

Protect your Muffle Free-Hanging Screen from excessive moisture when storing and handling.

## After Care

Using a dry cloth, give the panels a light dusting to keep them looking clean and fresh.

## Supplier

[za.muffleacoustics.com](http://za.muffleacoustics.com)

[hello.za@muffleacoustics.com](mailto:hello.za@muffleacoustics.com)

+44 (0) 1924 938911

Note: Product MUST be checked for colour shading differences, flaws, defects or damage prior to installation. Once installation has been commenced, the products are deemed to have arrived in perfect condition – any of the above reported after installation will not be covered by your warranty.