

Ecophon Focus B

600x600
M03

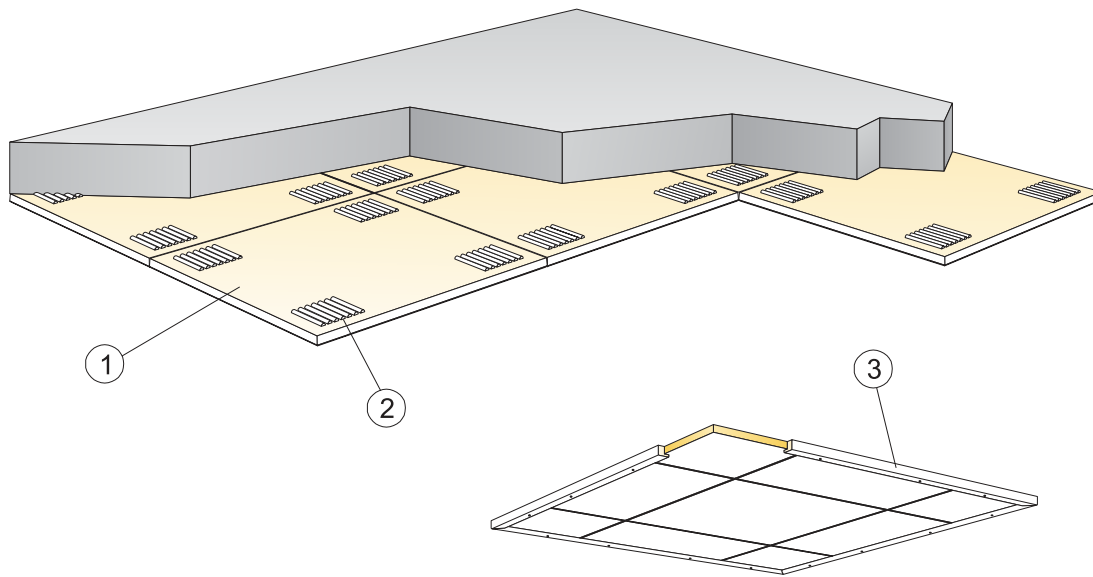

1. Ecophon Focus B

2. Connect Absorber glue



3. Connect Wood trim

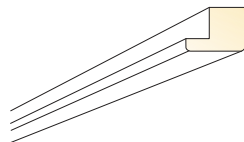

4. Connect Notched spatula

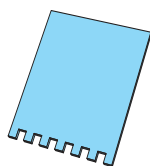

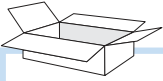

Connect Notched spatula

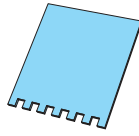

x1

Ensure a smooth, clean, dry strong surface before installation.
Suitable surfaces are plasterboard, concrete, light concrete or building board.
Avoid surfaces which are sensitive to moisture or water. The surface, the tiles and the glue must be at a temperature of 10-25°C.

In case of doubt or uncertainty, an adhesion test should be carried out prior to the installation. Please contact your Ecophon representative.



Step-by-step installation video available on ecophon.com

Ecophon
SAINT-GOBAIN

www.ecophon.com

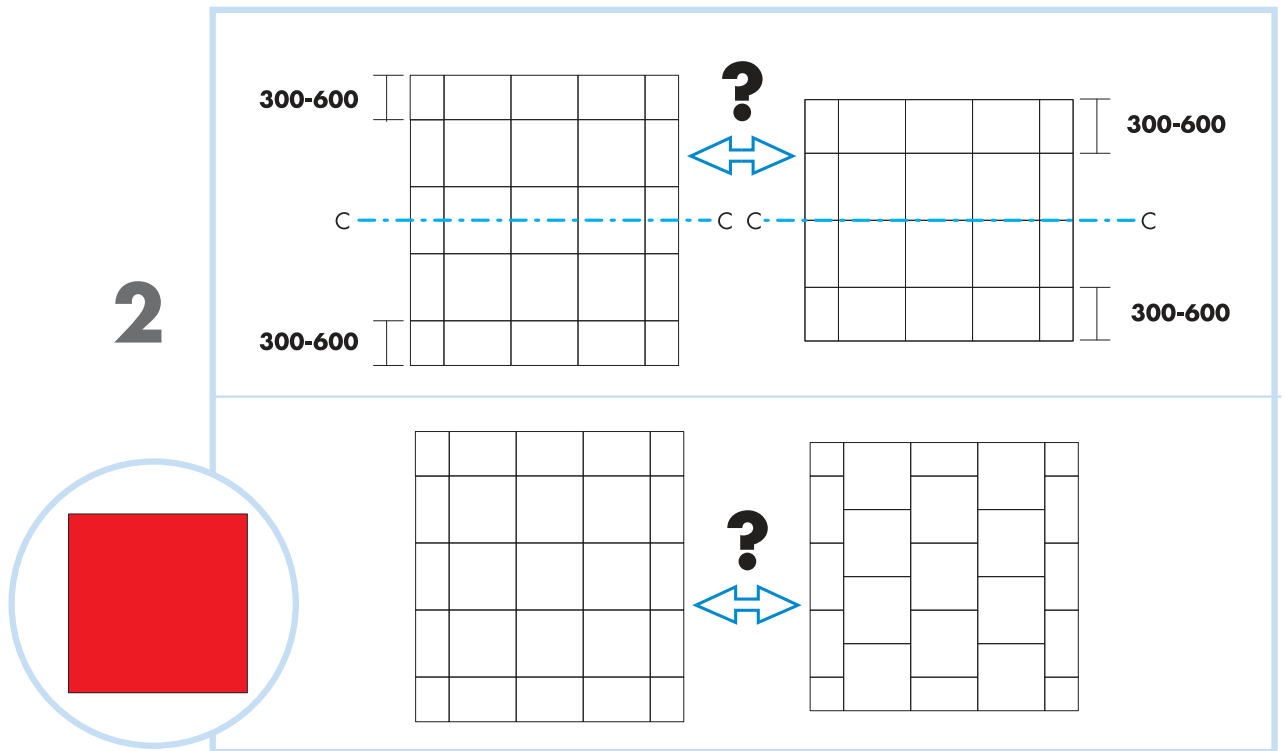
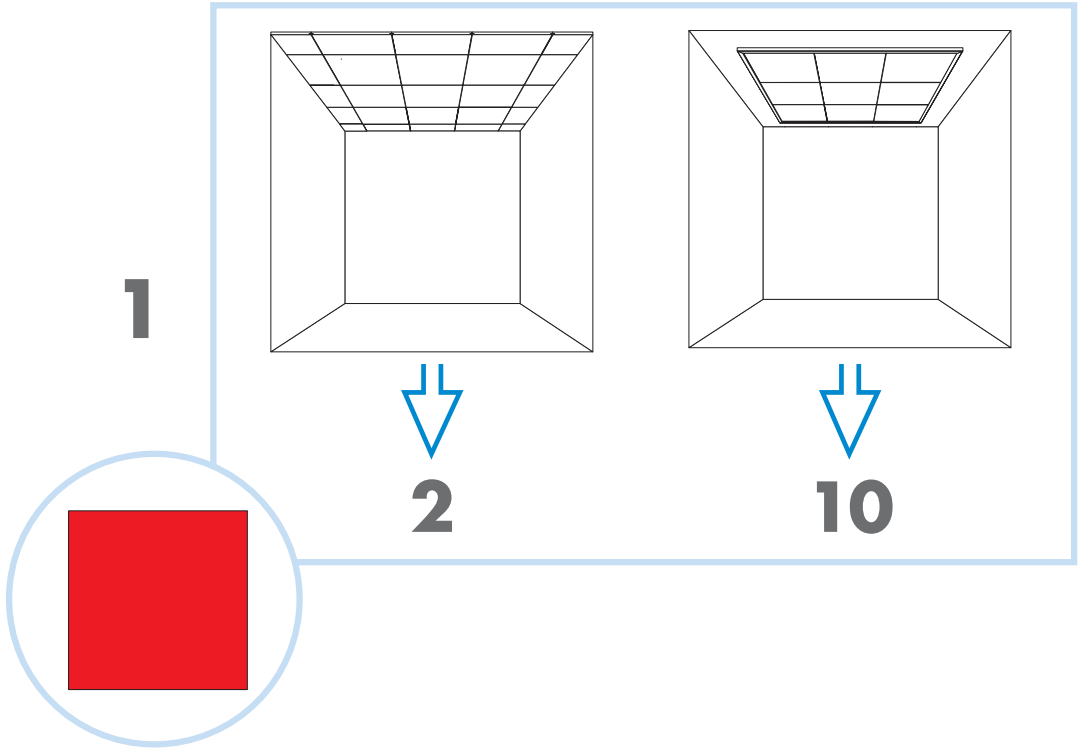

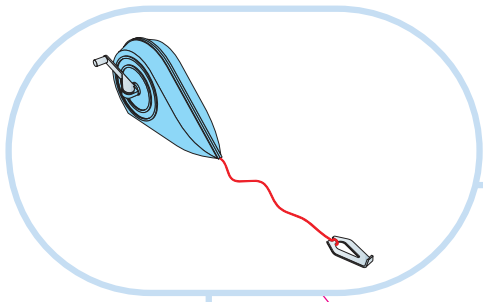

3

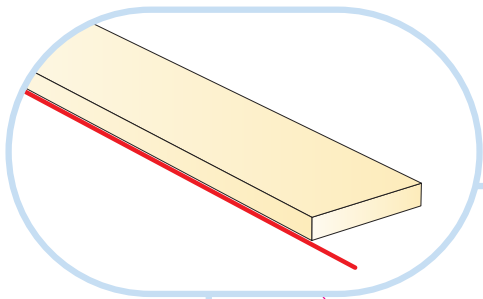
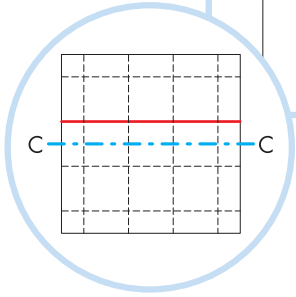

4

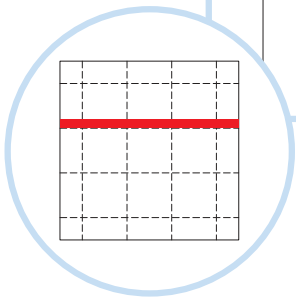
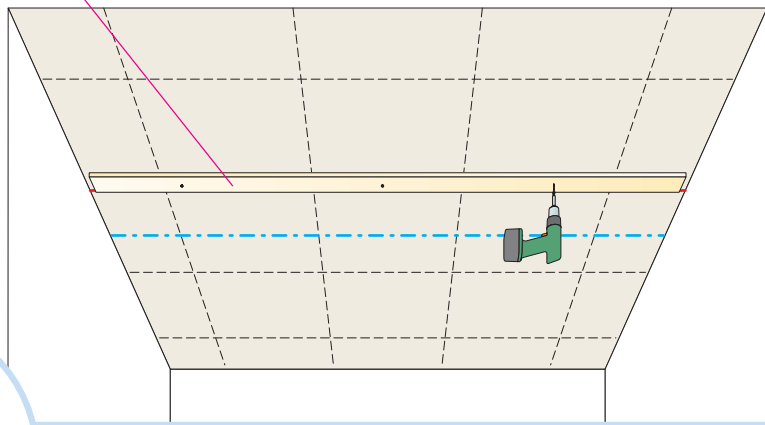

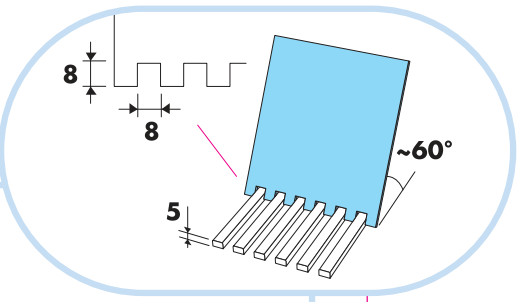
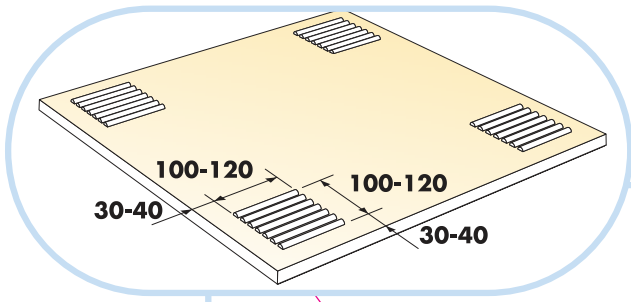

5

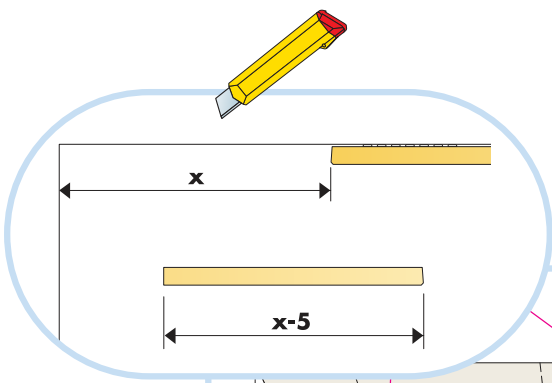
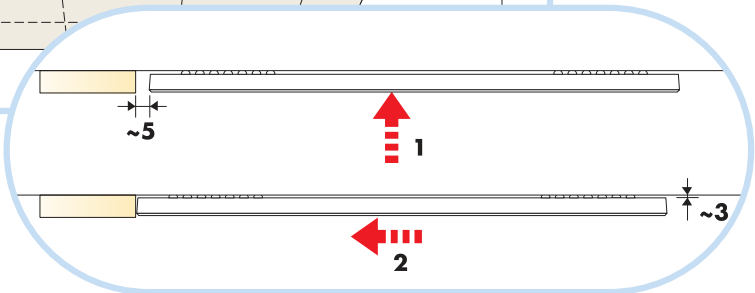
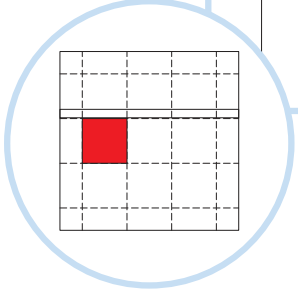
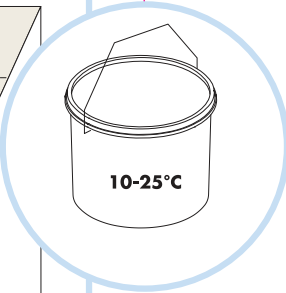
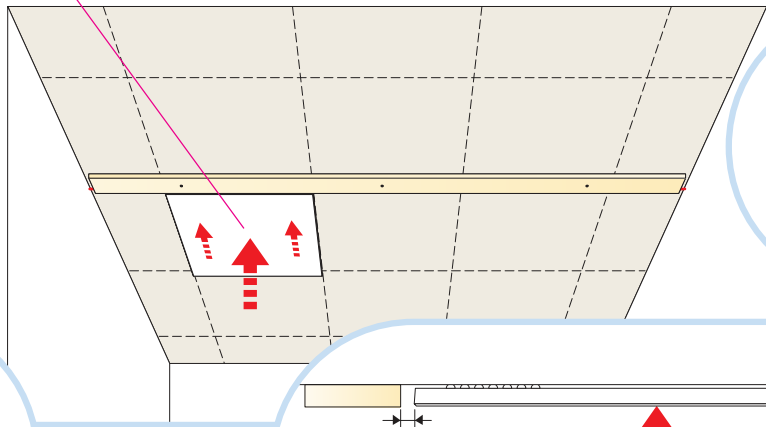

6

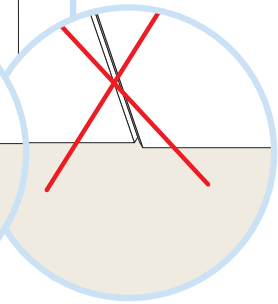
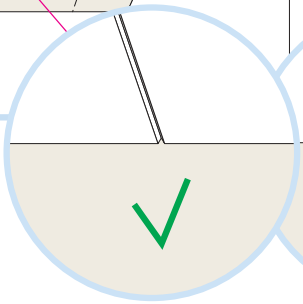
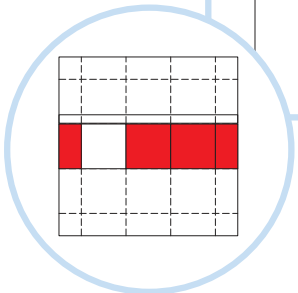
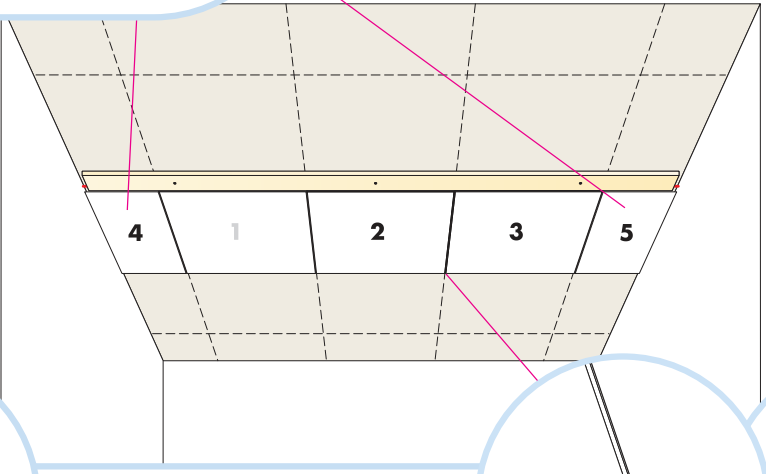

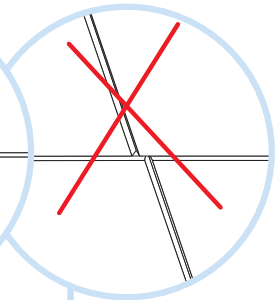
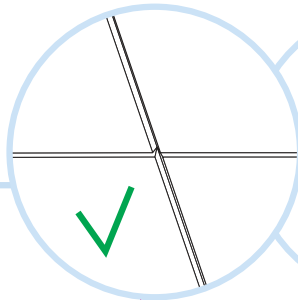
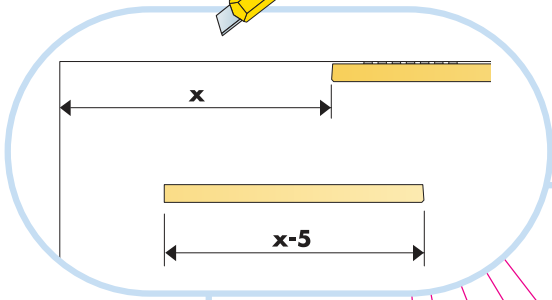

7

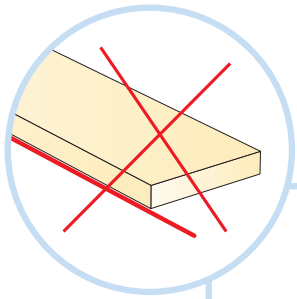
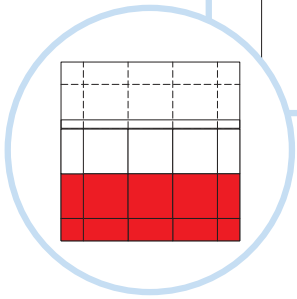
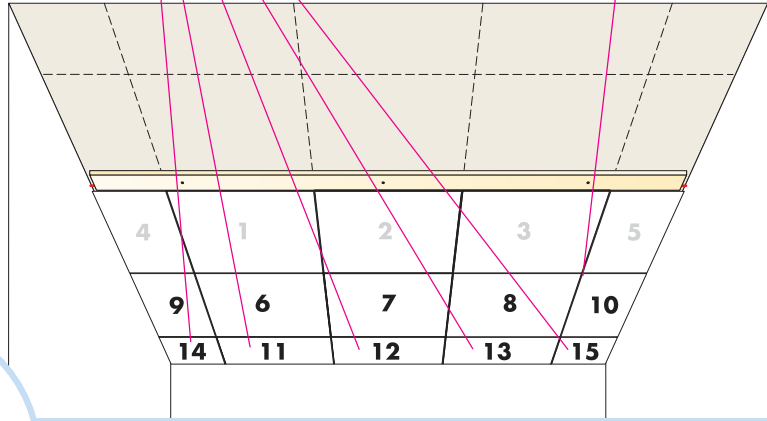

8

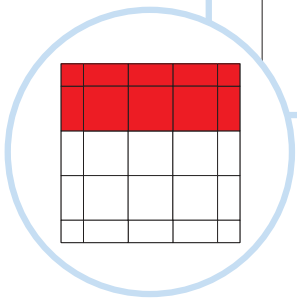
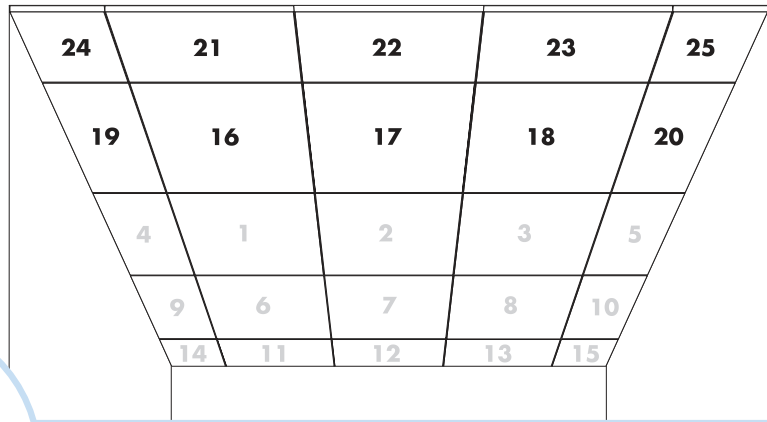

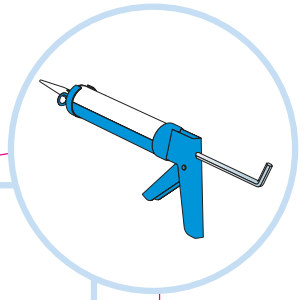
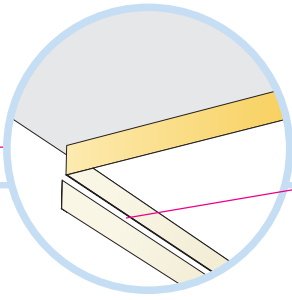
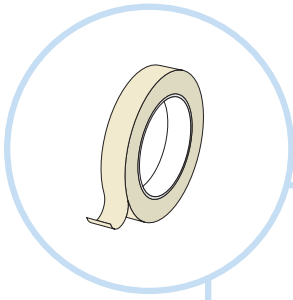

9

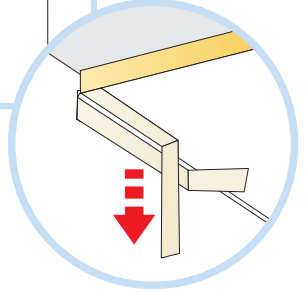
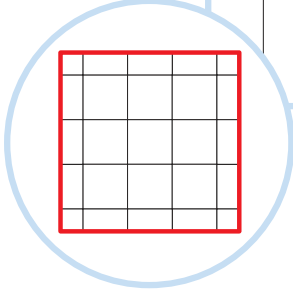
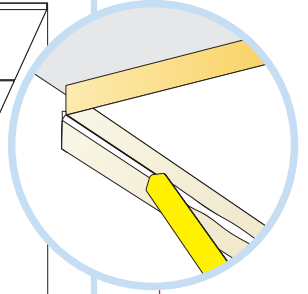
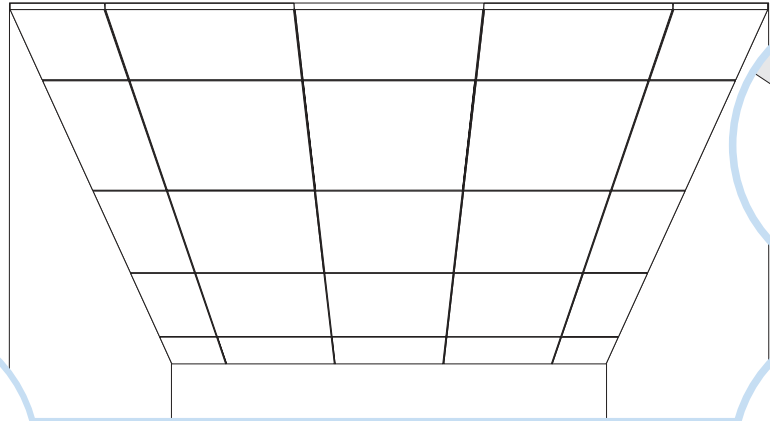

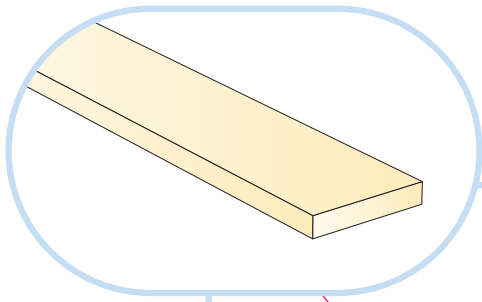

10

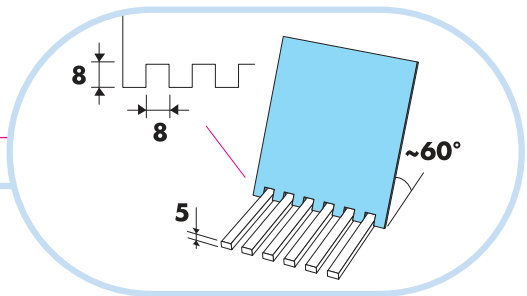
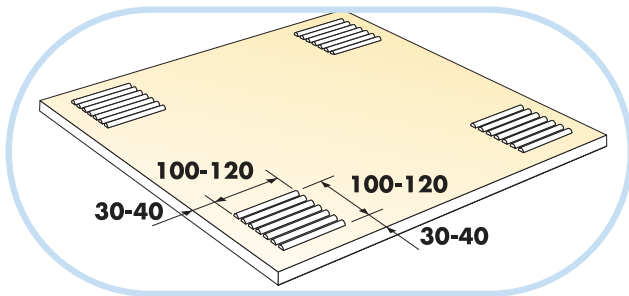
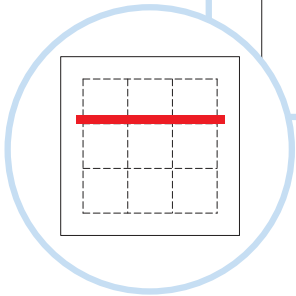
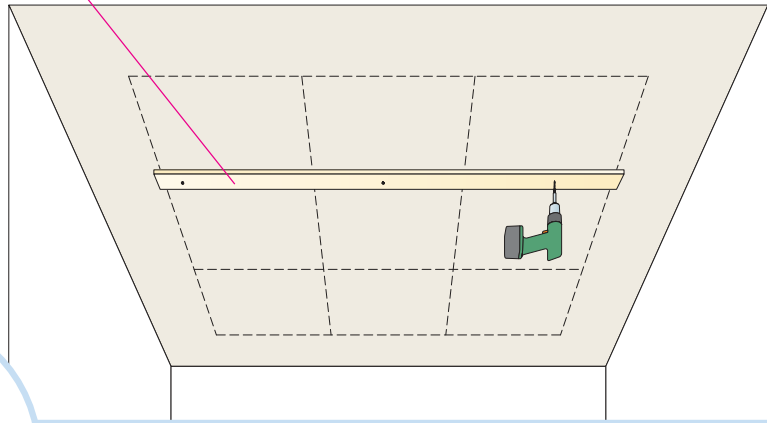

11

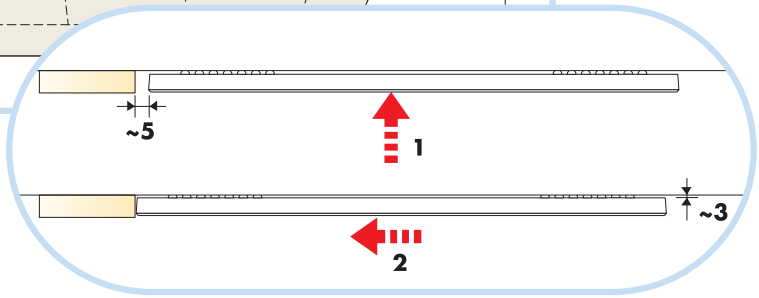
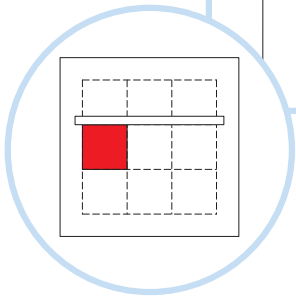
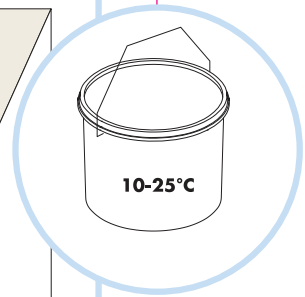
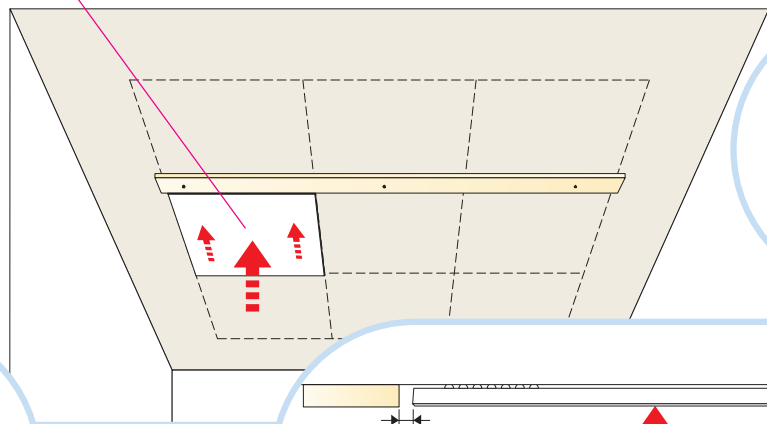

12

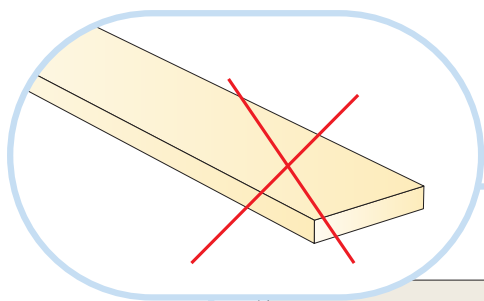
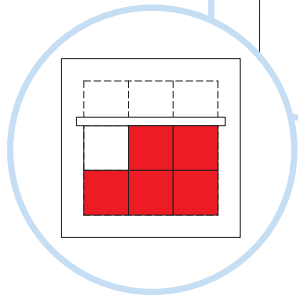
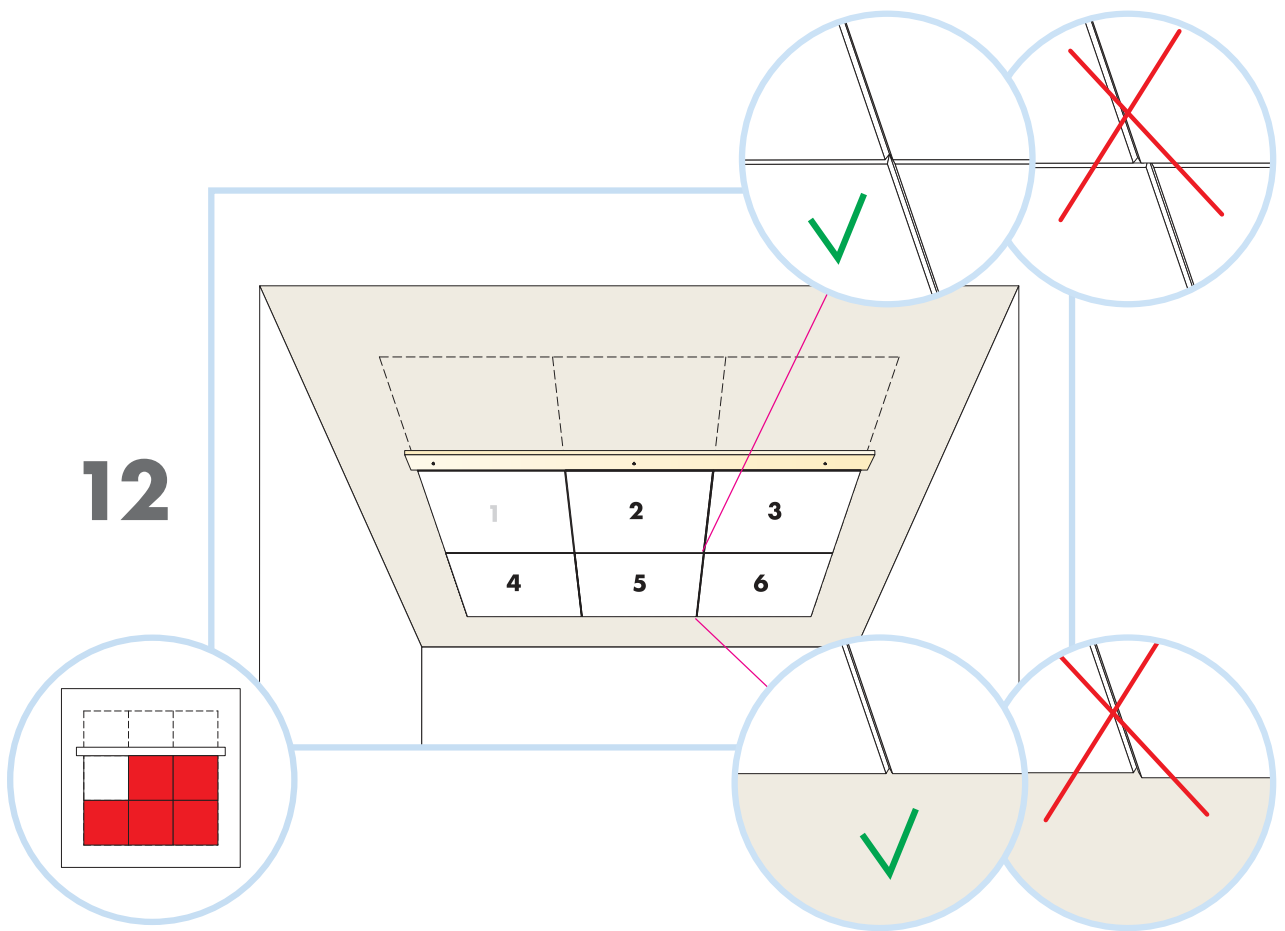

13

